

# X-Station 2

## USER GUIDE

Version 1.04

English

EN 102.00.XS2-ODPB, XS2-OAPB

# CONTENTS

<b>Safety instructions</b>	<b>3</b>	<b>Authentication</b>	<b>15</b>
Instructional icons	3	Auth Mode	15
		Modifying Auth Mode	15
		Delete Auth Mode	16
		Add Auth Mode	16
<b>Introduction</b>	<b>6</b>	Operation	16
Components	6	QR/Barcode Operation	17
Name and function of each part	7	Fingerprint	18
Cables and connectors	8	T&A Mode	19
How to enroll a fingerprint	9		
Note for QR/Barcode Usage and Device License	10	<b>Display &amp; Sound</b>	<b>20</b>
How to scan a QR/Barcode	10		
Notes for Device License	10		
		<b>Network</b>	<b>21</b>
<b>Admin Menu</b>	<b>11</b>	Network Settings	21
All Menus	11	Ethernet	21
		Server	22
		OSDP Setting	23
<b>User</b>	<b>12</b>		
Registering user information	12		
Registering a fingerprint	13		
Modifying User Information	13		
Delete All Users	14		
View User Usage	14		

# CONTENTS

<b>Device</b>	<b>24</b>	<b>Troubleshooting</b>	<b>32</b>
License	24		
Relay	25	<b>Product specifications</b>	<b>33</b>
Date & Time	25	Dimensions	35
Daylight Saving Time	26		
Device Info	27	<b>FCC compliance information</b>	<b>36</b>
Memory Info	27		
USB Memory	28	<b>EU Declaration of Conformity (CE)</b>	<b>36</b>
Secure Tamper	29		
Restart Device	29	<b>Appendices</b>	<b>37</b>
Restore Default	29	Disclaimers	37
User ID Type	29	Copyright notice	37
		Open Source License	38
<b>Event Log</b>	<b>30</b>	GNU General Public License	38
Search Log	30	TERMS AND CONDITIONS	39
Delete All Logs	30	BoringSSL License	45
View Log Usage	31	OpenSSL License	45
		Original SSLey License	46
		Licenses for support code	47
		Apache License	48

# Safety instructions

Please read this safety instructions before you use the product to prevent injury to yourself and others and to prevent property damage. The term 'product' in this manual refers to the product and any items provided with the product.

## Instructional icons



**Warning:** This symbol indicates situations that could result in death or severe injury.



**Caution:** This symbol indicates situations that may result in moderate injury or property damage.



**Note:** This symbol indicates notes or additional information.



## Warning

### Installation

**When using a high-capacity power supply, please pay special attention to avoid miswiring.**

- Miswiring may result in serious fire, electric shock, or product damage.

**Do not install or repair the product arbitrarily.**

- This may result in electric shock, fire, or product damage.
- Damages caused by any modifications or failure to follow installation instructions can void your manufacturer's warranty.

**Do not install the product in a place with direct sunlight, moisture, dust, soot, or a gas leak.**

- This may result in electric shock or fire.

**Install the product in a well-ventilated and cool place away from direct sunlight to prevent overheating when installing it outside.**

**Do not place the product inside the sealed enclosure when installing it outside.**

- It increases the internal temperature of the enclosure and this may result in electric shock, fire, or malfunction.

**Do not install the product in a location with heat from an electric heater.**

- This may result in fire due to overheating.

**Install the product in a dry location.**

- Humidity and liquids may result in electric shock or product damage.

**Do not install the product in a location where it will be affected by radio frequencies.**

- This may result in fire or product damage.

### Operation

**Keep the product dry.**

- Humidity and liquids may result in electric shock, fire, or product damage.

**Do not use damaged power supply adapters, plugs, or loose electrical sockets.**

- Unsecured connections may cause electric shock or fire.

**Do not bend or damage the power cord.**

- This may result in electric shock or fire.



## Caution

### **Installation**

Please read this manual before installing the product to ensure a safe and correct installation.

When wiring the power cable and other cables, make sure to connect them with the power turned off for all devices involved.

- The product may malfunction.

Before connecting power to the product, double-check the manual to ensure that the wiring is correct, then connect the power.

Do not install the product under direct sunlight or UV light.

- This may result in product damage, malfunction, discoloration, or deformation.

Do not install the power supply cable in a location where people pass by.

- This may result in injury or product damage.

Do not install the product near magnetic objects, such as a magnet, TV, monitor (especially CRT), or speaker.

- The product may malfunction.

Keep the minimum distance between products when installing multiple products.

- The product may be affected by radio frequencies emitted by other products and the product may malfunction.

Use the IEC/EN 62368-1 approved power adapter that supports higher power consumption than the product. It is highly recommended to use the power adapter sold by Suprema.

- If the right power supply is not used, the product may malfunction.
- Refer to the **Power** in the product specifications for maximum current consumption specifications.

Use a separate power supply for the Secure I/O 2, electric lock, and the product.

- If connecting and using the same power supply, the product may malfunction.

Do not connect and use the power supply and Power over Ethernet (PoE) simultaneously.

- The product may malfunction.

Make sure that the cable cover is completely closed after connecting it to the product to maintain the waterresistant and dust-resistant features (IP65 rating). It is recommended to use the enclosure if the product is installed outside.

- The product may malfunction if the water-resistant and dust-resistant features are damaged.



## Caution

### **Operation**

**Do not drop the product or cause impacts to the product.**

- The product may malfunction.

**Do not disconnect the power supply while upgrading the firmware of the product.**

- The product may malfunction.

**Do not disclose the password to others and change it regularly.**

- This may result in illegal intrusion.

**Do not press buttons on the product by force or do not press them with a sharp tool.**

- The product may malfunction.

**Do not store your product in very hot or very cold places. It is recommended to use your product at temperatures from -20 °C to 50 °C.**

- The product may malfunction.

**When cleaning the product, mind the following.**

- Wipe the product with a clean and dry towel.
- If you need to sanitize the product, moisten the cloth or the wipe with a proper amount of rubbing alcohol and gently clean all exposed surfaces including fingerprint sensor. Use rubbing alcohol (containing 70% Isopropyl alcohol) and a clean, non-abrasive cloth like lens wipe.
- Do not apply liquid directly to the surface of the product.

**Do not use the product for anything other than its intended use.**









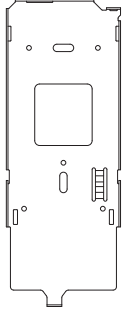
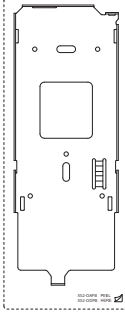

- The product may malfunction.

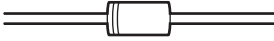
### **RTC Battery**

Use of an unapproved or incorrect type of battery may result in a risk of explosion. Discard the battery according to the appropriate regional or international waste regulations.

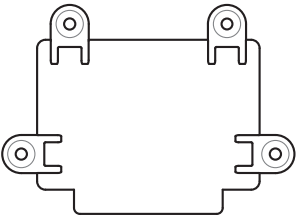
# Introduction

## Components

			
<p><b>X-Station 2</b></p>	<p><b>Wall Bracket</b></p>	<p><b>Drilling Template</b></p>	
			
<p><b>Connection Cables</b></p>	<p><b>Diode</b></p>	<p><b>120 Ω Resistor</b></p>	
			
<p><b>PVC Anchor x2</b></p>	<p><b>Fixing Screw x2</b></p>	<p><b>Bracket Fixing Screw (Star Shaped)</b></p>	
			
<p><b>Cable Cover</b></p>	<p><b>Shrink Tube</b></p>	<p><b>Quick Guide</b></p>	<p><b>Open Source Software Guide</b></p>



- Components may vary according to the installation environment.
- When assembling the product with the bracket, you can use the included bracket fixing screw (Star Shaped) instead of the product fixing screw for enhanced security.
- For more details regarding the product installation, visit the Suprema website (<https://www.supremainc.com>) and refer to the installation guide.

## Name and function of each part

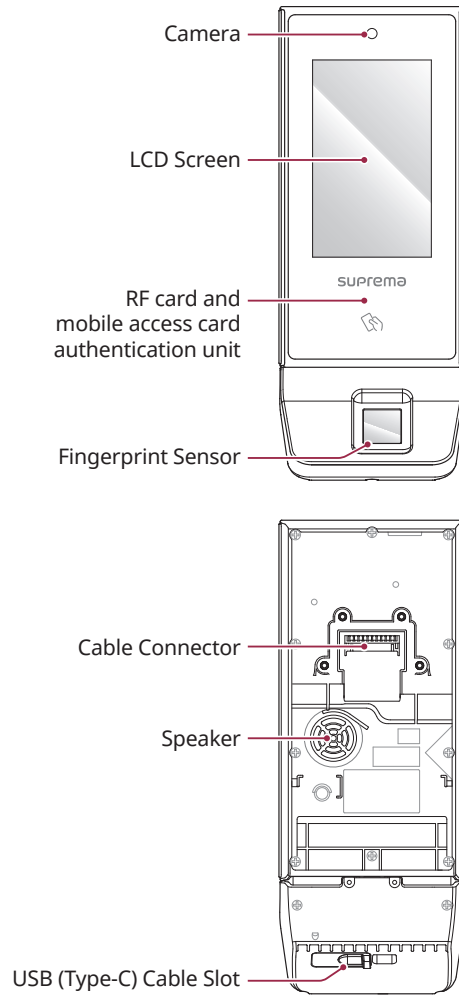

Name	Description
Camera	Captures actual images.
LCD Screen	Provides UI for operation.
RF card and mobile access card authentication unit	Part to scan a RFID card or mobile access card for entrance.
Fingerprint Sensor	Reads fingerprints.
Cable Connector	Connects cables. <ul style="list-style-type: none"> <li>• Power supply</li> <li>• Ethernet + PoE</li> <li>• RS-485</li> <li>• Wiegand input and output</li> <li>• TTL input</li> <li>• Relay</li> </ul>
Speaker	Delivers sound.
USB (Type-C) Cable Slot	Connects the USB cable.



## Cables and connectors

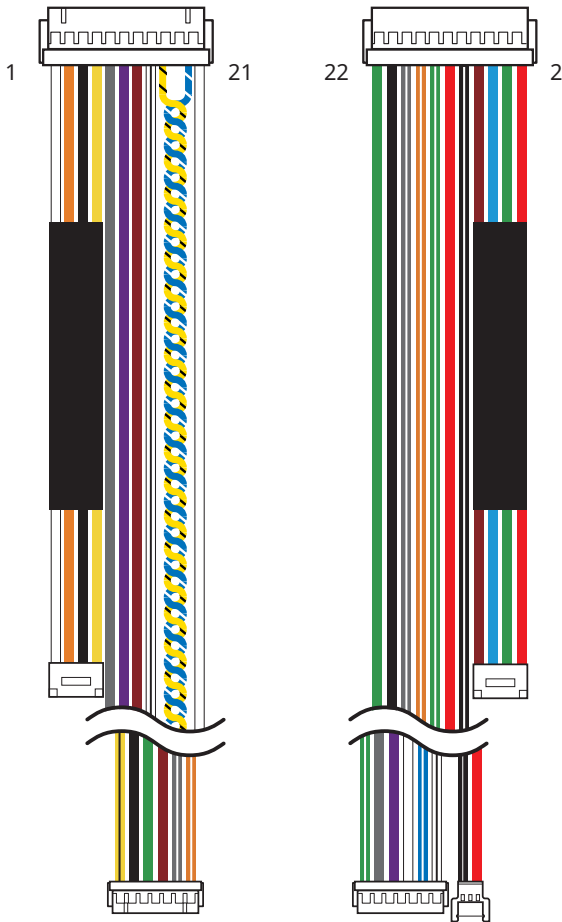

Cable	PIN	Name	Color
RJ-45 (Ethernet + PoE)	1	ENET TXP	White
	3	ENET TXN	Orange
	5	ENET RXP	Black
	7	ENET RXN	Yellow
TTL input	9	TTL GND	Gray
	11	TTL IN0	Purple
	13	TTL IN1	Brown
RS-485	15	485 GND	White (Black stripe)
	17	485 TRXN	Yellow (Black stripe)
	19	485 TRXP	Blue (White stripe)
Wiegand	21	WG D1	White
	22	WG D0	Green
	20	WG GND	Black
Relay	18	RLY NO	Gray (White stripe)
	16	RLY NC	Orange (White stripe)
	14	RLY COM	Green (White stripe)
Power	12	PWR +VDC	Red
	10	PWR GND	Black (White stripe)
RJ-45 (Ethernet + PoE)	8	VB2	Brown
	6	VB2	Blue
	4	VB1	Green
	2	VB1	Red

## How to enroll a fingerprint

In order to improve the fingerprint authentication rate, register the fingerprint correctly. X-Station 2 can recognize a fingerprint even if the angle and position of a user's fingerprint input change. If you register the fingerprint with attention to the following matters, the authentication rate can be improved.

### Selecting a finger for fingerprint input

- In preparation for the case that the fingerprint of a specific finger cannot be used, for example if the user is lifting a load with one hand or a finger gets hurt, up to 10 fingerprints for each user can be registered.
- In the case of a user whose fingerprint cannot be recognized well, the authentication rate can be improved by enrolling the same finger twice repeatedly.
- If a finger has a cut or the fingerprint is blurry, select another finger for the fingerprint.
- It is recommended to use the index finger or the middle finger when scanning the fingerprint. The authentication rate can be reduced if it is difficult to place another finger at the center of fingerprint sensor accurately.

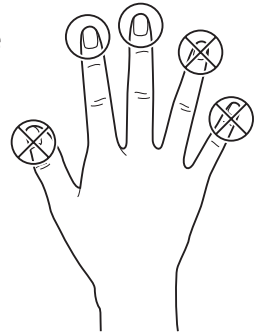

### Fingerprint enroll method

- 1 When a message saying "Scan Finger" is displayed on the LCD screen for enrolling the fingerprint, place the finger with the fingerprint you wish to enroll on the fingerprint sensor and press the finger gently for better authentication.

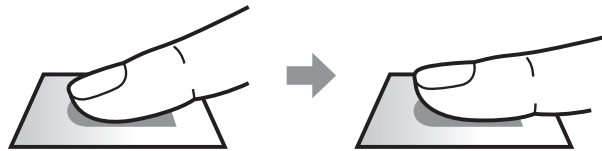

- 2 When the re-input screen is displayed after a beep sound, scan the fingerprint of the enrolled finger again. (scan the fingerprint of a finger to be enrolled twice)



#### Cautions for enrolling a fingerprint

When a fingerprint is recognized, it is compared with the initially registered fingerprint, so the initial fingerprint enroll is the most important. Pay attention to the following matters when enrolling the fingerprint.

- Place the finger deep enough to contact with the sensor completely.
- Place the center of the fingerprint in the center of the sensor.
- If a finger has a cut or the fingerprint is blurry, select another finger for the fingerprint.
- Scan the fingerprint correctly without moving according to the instruction on the screen.
- If you make the finger upright so that the contact area with the sensor is decreased or the angle of finger is warped, fingerprint authentication may not be performed.



#### When the fingerprint recognition fails

X-Station 2 can recognize a fingerprint regardless of a change in season or finger condition. However, the authentication rate may vary according to the external environment or fingerprint input method. If the fingerprint authentication cannot be done smoothly, it is recommended to take the following measures.

- If the finger is smeared with water or sweat, dry off the finger and then scan the finger.
- If the finger is too dry, blow your breath on the fingertips and then scan the finger.
- If the finger has a cut, register the fingerprint of another finger.
- The initially enrolled fingerprint often may have not been scanned correctly, so enroll the fingerprint again according to 'Cautions for enrolling a fingerprint'.

## Note for QR/Barcode Usage and Device License

You can issue a QR/Barcode to a user and use it as an authentication method. Scan the QR/Barcode properly by following the instructions on the screen to increase the recognition rate.

### How to scan a QR/Barcode

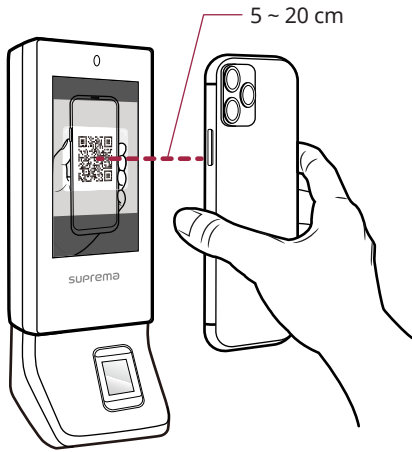

- Keep 5-20 cm of distance between the device's camera and the QR/Barcode.
- Position the QR/Barcode in the center of the scan screen of the device.
- When authenticating with the QR/Barcode downloaded to your smartphone, adjust the brightness of your smartphone so that the device can read the QR/Barcode clearly.
- If do not follow the instructions on the screen, it may take a long time to scan the QR/Barcode, or it may fail.

### Notes for Device License

- Using the QR/Barcode authentication requires a separate device license. Contact the place of purchase to issue a device license.
- The device license file is an encrypted file and cannot be modified arbitrarily.
- Device licenses are issued based on device ID. If the device ID is changed in an unusual way, the warranty service for the license is not provided.

# Admin Menu

## All Menus

- 1 Press  and authenticate with the Admin level credential.
- 2 Select the desired menu.

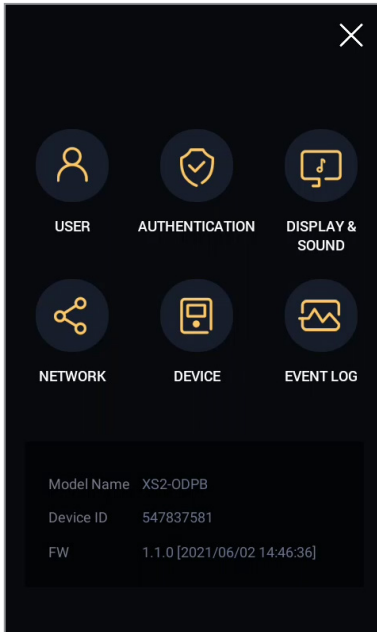

If the administrator has not been designated, the menu screen will be displayed when you press .

## Registering user information



The user information including credentials can be registered.

1 Press  and authenticate with the Admin level credential.

2 Select **USER** → , and choose a credential you want to register.

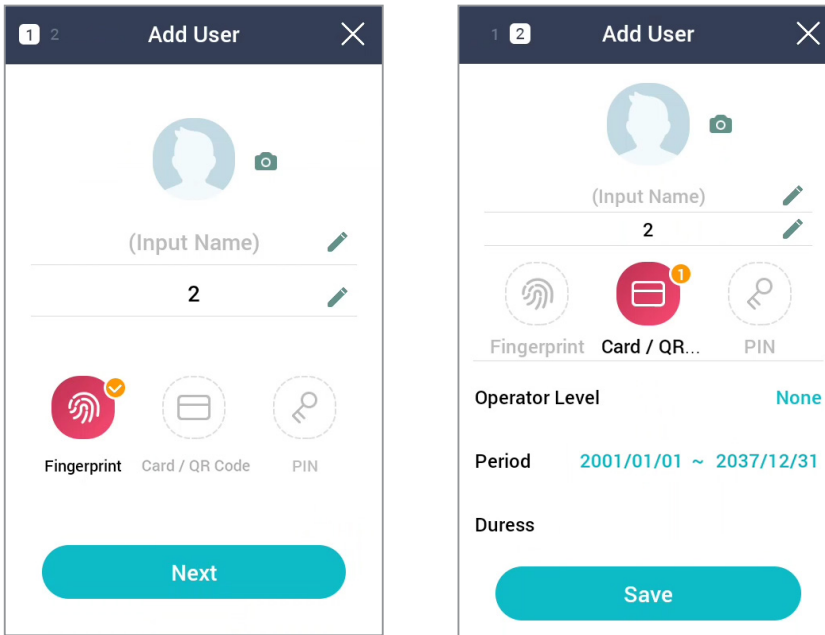
There are two steps for the user registration. Some options are available after the credential has been registered.



- : Take a picture of a user with the built-in camera.
- **Name:** Enter the username.
- **ID:** Enter a number between 1 and 429467295 to register as the user ID. If User ID Type set to Alphanumeric, a combination of alphanumeric characters and symbols (., -) can be used for the ID. Up to 32 characters can be input.
- **Fingerprint:** Register a fingerprint for user authentication. Press **Fingerprint** → **Next** and register a fingerprint according to the instructions on the screen. To add more fingerprint, press . Refer to [Registering a fingerprint](#) to learn more about the fingerprint registration.
- **Card / QR Code:** Register a card for user authentication. Press **Card / QR Code** → **Next** and scan the card that will be assigned to the user. To register an additional card, press .
- **PIN:** Enter the PIN you wish to use. Enter the PIN you wish to use, and then enter the same PIN again for confirmation. Enter a number between 4 and 16 digits to prevent leaking.
- **Operator Level:** Select the level you wish to assign to a user.





Available menus vary according to the set user level.

- **None:** This is the general user level and menus cannot be accessed.
- **Administrator:** All menus can be accessed.
- **Configuration:** **AUTHENTICATION, DISPLAY & SOUND, NETWORK, DEVICE, and EVENT LOG** menus can be accessed.
- **User Management:** **USER and EVENT LOG** menu can be accessed.

- **Period:** Set an expiry date to use the user account.
- **Duress:** Select this option to add the fingerprint as a duress fingerprint. When threatened by someone to open the door, the user can authenticate using this fingerprint to send an alarm signal to BioStar 2.
- **Private Auth Mode:** Change the authentication method according to the user.

## Registering a fingerprint



- 1 Press  and authenticate with the Admin level credential.
- 2 Select **USER** → .
- 3 Select  **Fingerprint** → **Next**.



- Place the finger deep enough to contact with the sensor completely.
- Place the center of the fingerprint in the center of the sensor.
- If a finger has a cut or the fingerprint is blurry, select another finger for the fingerprint.
- Scan the fingerprint correctly without moving according to the instruction on the screen.
- If you make the finger upright so that the contact area with the sensor is decreased or the angle of finger is warped,
- fingerprint authentication may not be performed.

## Modifying User Information

User Management or Administrator can modify the registered user information. A card or fingerprint can be added, and PIN and level can be modified.



- 1 Press  and authenticate with the Admin level credential.
- 2 Select **USER** → .
- 3 Select your search terms. You can search for a user by **All**, **User ID**, **Name**, **Fingerprint**, and **Card**.
- 4 Select a user you wish to modify.
- 5 Modify the information by referring to **Registering user information** and press **OK**.
  - To delete a user, select  and then press **OK**.



**Access Group** can be registered in BioStar 2. For detailed contents regarding registering an access group, refer to the BioStar 2 Administrator Manual.



## Delete All Users

You can delete all registered users at once.

- 1 Press  and authenticate with the Admin level credential.
- 2 Select **USER** → .
- 3 Check **Delete All** to delete all registered users and press **OK**.
- 4 When you press **OK**, all registered users will be deleted.

## View User Usage

You can see the number of registered users, and cards at a glance.

- 1 Press  and authenticate with the Admin level credential.
- 2 Select **USER** → . User usage information appears.

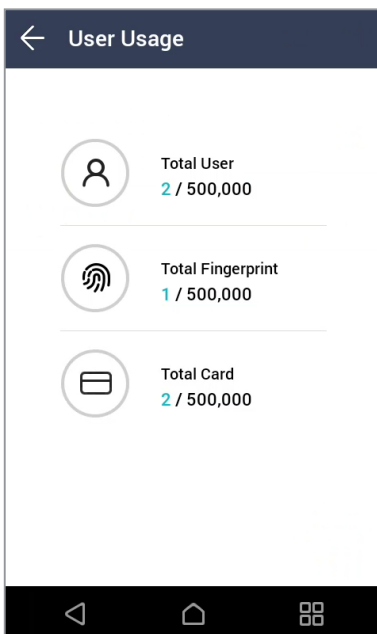



# Authentication

## Auth Mode

### Modifying Auth Mode



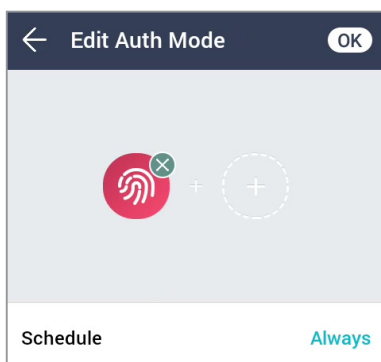

You can set the authentication method and schedule according to each credential.

- 1 Press  and authenticate with the Admin level credential.
- 2 Select **AUTHENTICATION** → **Auth Mode**.
- 3 Select the authentication mode to modify.
- 4 When you press , the selected credential will be deleted, and when you press , available credentials to be added will be displayed on the screen.





- 5 Set the desired auth mode and select a schedule.
- 6 When you press **OK**, settings will be saved.





- You can combine selected authentication mode to authenticate all in order or only some of the selected authentication mode to authenticate. For example, if you combines the authentication mode with  + , a user should authenticate fingerprint and a PIN, and if you combine the authentication mode with  +  / , a user authenticates a card first and fingerprint or a PIN.
- A schedule can be set in BioStar 2. If there is no set schedule, only **Always** can be selected.
- For detailed contents regarding setting a schedule, refer to BioStar 2 Administrator's manual.
- To use **QR/Barcode** authentication, **QR/Barcode** must be activated in **AUTHENTICATION** → **QR/Barcode Operation**, and a separate device license is required. For more information, refer to [License](#).



## Delete Auth Mode

- 1 Press  and authenticate with the Admin level credential.
- 2 Select AUTHENTICATION → Auth Mode.
- 3 Press  and select the authentication mode to delete. You can select multiple options.
- 4 Press OK. To delete the selected option, press OK. Or, press Cancel to cancel the deletion.

## Add Auth Mode

- 1 Press  and authenticate with the Admin level credential.
- 2 Select AUTHENTICATION → Auth Mode.
- 3 Press .
- 4 Set the desired auth mode by pressing , and then select a schedule.
- 5 When you press OK, the auth mode will be added.

## Operation

- 1 Press  and authenticate with the Admin level credential.
- 2 Press AUTHENTICATION and then modify items below Operation.

Operation	
Auth Timeout	10 Sec
Server Matching	<input type="checkbox"/>

- **Auth Timeout:** If the authentication is not completed during a set time, the authentication will fail. You can set a time between 3 seconds and 20 seconds.
- **Server Matching:** When you set Server Matching, the user authentication is not carried out in the device, but instead is carried out in BioStar 2. Server Matching can be useful when there is a large amount of user information in the device or you do not wish to publicly expose the device where user credential information is saved.

## QR/Barcode Operation

- 1 Press  and authenticate with the Admin level credential.
- 2 Press **AUTHENTICATION** and then modify items below **QR/Barcode Operation**.

QR/Barcode Operation	
QR/Barcode	<input checked="" type="checkbox"/>
Camera Timeout	10 Sec
Motion Sensor	Medium
Use QR as Card	<input type="checkbox"/>

- **QR/Barcode:** Set to use QR code or Barcode to authenticate.
- **Camera Timeout:** If you do not scan the QR code or Barcode within the set time, the authentication will fail. You can set a time between 3 seconds and 20 seconds. It can be set only when **QR/Barcode** is activated.
- **Motion Sensor:** Set the sensitivity for detecting motion near the device. It can be set only when **QR/Barcode** is activated.
- **Use QR as Card:** Allows authentication with a QR code of the same data as the issued CSN card or Wiegand card. It can be set only when **QR/Barcode** is activated.



Using the **QR/Barcode** authentication requires a separate device license. For more information, refer to [License](#).

# Fingerprint

- 1 Press  and authenticate with the Admin level credential.
- 2 Press **AUTHENTICATION** and then modify items below **Fingerprint**.

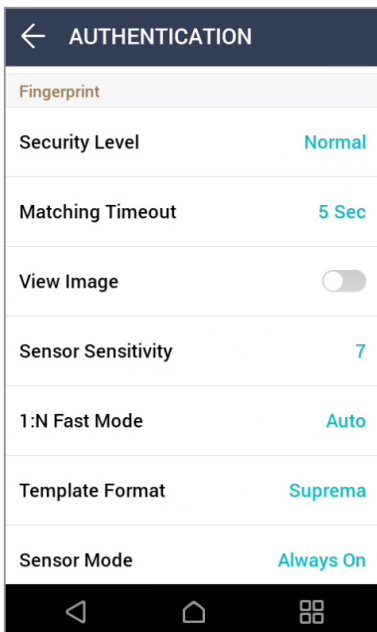

- **Security Level:** Set the security level for 1:N authentication.
- **Matching Timeout:** Set the fingerprint matching timeout. If the authentication is not completed during a set time, the authentication will fail.
- **View Image:** Set to view the original image when scanning the fingerprint.
- **Sensor Sensitivity:** Set the sensitivity of the fingerprint authentication sensor. To obtain more precise fingerprint information by increasing the sensor sensitivity, set the sensor sensitivity higher.
- **1:N Fast Mode:** Set the fingerprint authentication speed. If you select **Auto**, the authentication speed will be set according to all fingerprint templates enrolled on the device.
- **Template Format:** Set the fingerprint template format. SUPREMA is set as the default, and if you change the template format, all fingerprints saved previously cannot be used. Use caution when changing the Template Format.
- **Sensor Mode:** When **Auto On** is set, the fingerprint sensor recognizes a user's fingerprint and turns on. When **Always On** is set, the sensor is always on.
- **Live Fingerprint Detection:** Set the level of the fake fingerprint detection. The higher the fake fingerprint detection level, the higher the rejection rate of fingerprint.
- **Advanced Enrollment:** Inspect the quality of a scanned fingerprint in order to save high quality fingerprint information. When Use is set and the quality of the fingerprint is low, it notifies such information to the user and helps the user scan the fingerprint correctly.
- **Duplicate Check:** When registering fingerprints, you can check duplicates.

## T&A Mode

You can set how to register T&A Mode.

- 1 Press  and authenticate with the Admin level credential.
- 2 Press **AUTHENTICATION** and then modify items below **T&A Mode**.

T&A Mode	
T&A Mode	Fixed
T&A Code	0
Fixed T&A Key	Code 1 (In)
Job Code	<input type="checkbox"/>

- 3 Select and set the desired item.
  - **T&A Mode:** Set the method to use T&A mode.
  - **T&A Code:** You can register T&A events. Select **T&A Code** →  to register a T&A event and set an icon, name of T&A event, and schedule.
  - **T&A Required:** Set to require a user to select a T&A event when authenticating. This option can be used when **T&A Mode** is set to **By User**.
  - **Fixed T&A Key:** Set to use only a T&A event selected by the administrator. This option can be used when **T&A Mode** is set to **Fixed**.
  - **Job Code:** Select whether to use **Job Code**.
- 4 To save settings, press **OK**.

# Display & Sound

You can change the display and sound settings of the device.

- 1 Press  and authenticate with the Admin level credential.
- 2 Select **DISPLAY & SOUND**.
- 3 Change the desired item.

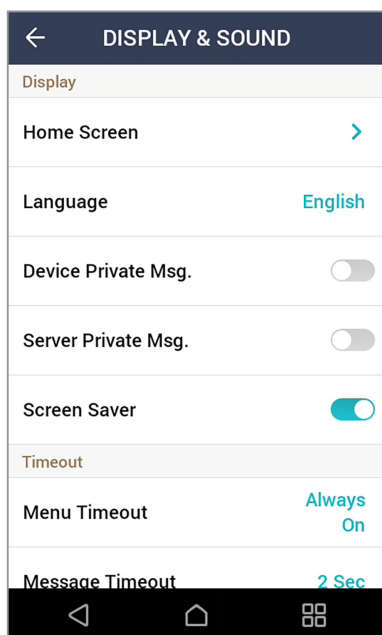

- **Home Screen:** Select items to be displayed in the background of the home screen.
- **Language:** Set the language you wish to use.
- **Device Private Msg.:** Set whether to use a Private Message, which will be displayed on the screen when the user authenticates. You can set **Device Private Msg.** by using the BioStar 2 Device SDK.
- **Server Private Msg.:** Set whether to use a Private Message, which will be displayed on the screen when the user authenticates. You can set the **Server Private Msg.** by using the BioStar 2 API. If you have not set it on the server, the device does not display a message when authentication is successful even if **Server Private Msg.** is enabled on the device.
- **Screen Saver:** Set this option to use the screen saver feature. It reduces unnecessary energy consumption by lowering the brightness of the LCD screen when the device is not in use.
- **Menu Timeout:** Set the time (sec) for the menu screen to disappear automatically. If there is no button input during a set time, the screen will return to the home screen.
- **Message Timeout:** Set the time (sec) for a setting complete message or information message to disappear automatically.
- **Backlight Timeout:** Set the time (second) to turn off the lighting of LCD screen.
- **Voice Instruction:** Set to use the voice instruction instead of alarm sounds.
- **Volume:** Set the volume.



Refer to the BioStar 2 Device SDK webpage on the Suprema Knowledge Base website ([kb.supremainc.com/bs2sdk/](http://kb.supremainc.com/bs2sdk/)) for more information on the BioStar 2 Device SDK.

# Network

## Network Settings

You can change the network settings of the device, such as Ethernet, server, OSDP, etc.

### Ethernet

- 1 Press  and authenticate with the Admin level credential.
- 2 Select **NETWORK** → **Ethernet**.
- 3 Change the desired item.

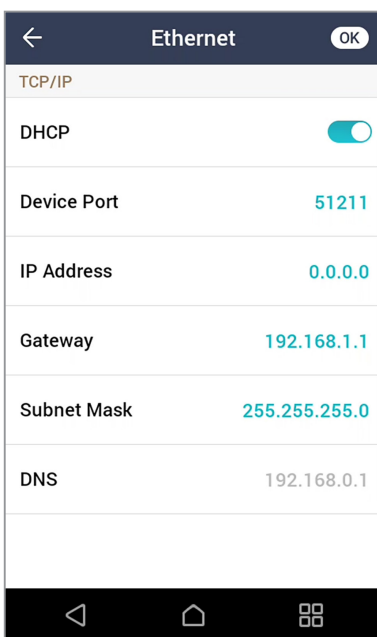

- **DHCP:** Set whether to use DHCP. If DHCP setting is disabled, the user can modify **IP Address**, **Gateway** and **Subnet Mask**.
  - **Device Port:** Set the device port.
  - **IP Address:** View the IP address of the device. To modify, disable DHCP setting.
  - **Gateway:** View the gateway of the device. To modify, disable DHCP setting.
  - **Subnet Mask:** View the subnet mask of the device. To modify, disable DHCP setting.
  - **DNS:** Set the DNS server address.
- 4 To save settings, press **OK**.

## Server

- 1 Press  and authenticate with the Admin level credential.
- 2 Select NETWORK → Server.
- 3 Change the desired item.

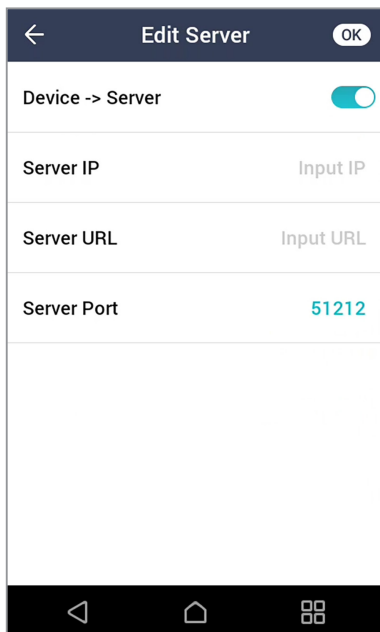

- **Device → Server:** You can send a connection signal from the device to a server with the input information directly. When you select **Server → Device**, **Server IP**, **Server URL** and **Server Port** cannot be entered.
  - **Server IP:** Enter the IP address of the PC on which BioStar 2 is installed. Input is accepted only when **Device → Server** is set for **Connection Mode**.
  - **Server URL:** Enter server URL instead of **Server IP**. Input is accepted only when **Device → Server** is set for **Connection Mode**.
  - **Server Port:** Enter the port of the PC on which BioStar 2 is installed. Input is accepted only when **Device → Server** is set for **Connection Mode**.
- 4 To save settings, press **OK**.

## OSDP Setting

- 1 Press  and authenticate with the Admin level credential.
- 2 Press **NETWORK** and then modify items below **OSDP Setting**.

OSDP Setting	
RS-485	Default
Baud Rate	115200
Authentication Result	Display Result from Controller



- **RS-485:** Select the RS-485 mode.
  - **Baud Rate:** Select the desired baud rate.
  - **Authentication Result:** When using **Intelligent Slave**, the authentication results of 3rd party controllers or devices can be selected to be displayed on the screen. This option can be used when **RS-485** is set to **Default** or **Slave**.
- 3 To save settings, press **OK**.



# Device

## License

You can activate device licenses or view **Licenses in Slave Devices** and **Activated Licenses in Device**.

- 1 Press  and authenticate with the Admin level credential.
- 2 Select **DEVICE** → **License**.
- 3 To activate the device license, connect the USB with the license to the device and select .

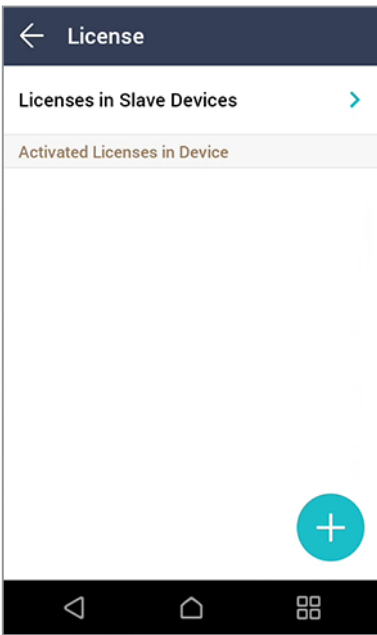

- 4 Licenses that can be activated appear on the screen. Activate the desired license.

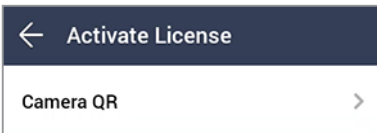

- Contact the place of purchase to issue a device license.
- One feature is available per device license.
- You can include multiple device licenses in one device license file. (Supports up to 100)
- The device license file is an encrypted file and cannot be modified arbitrarily.
- Device licenses are issued based on device ID. If the device ID is changed in an unusual way, the warranty service for the license is not provided.

## Relay

You can set the open time and the input port of the exit button in the device.

- 1 Press  and authenticate with the Admin level credential.
- 2 Select **DEVICE** → **Relay**.
  - **Relay:** You can set whether relay is enabled or not. To set the open time and the input port of the exit button, activate this option.
  - **Open Time:** Set the duration for the door to remain open when standard user authentication has been carried out.
  - **Exit Button:** Select the input port where the exit button is connected.
  - **Switch:** Select the relay type (N/O or N/C).

## Date & Time

You can set the open time and the input port of the exit button in the device.

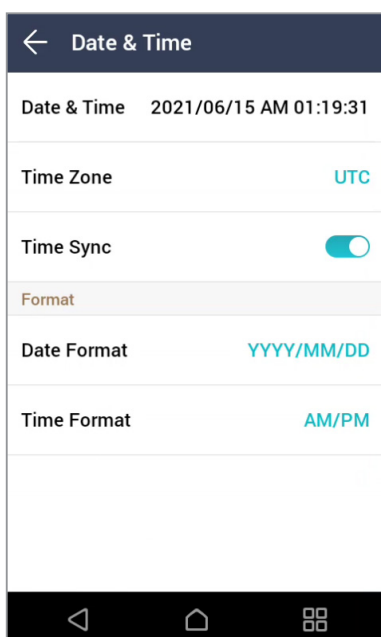

- 1 Press  and authenticate with the Admin level credential.
- 2 Select **DEVICE** → **Date & Time**.
- 3 Change the desired item.



- **Date & Time:** Check the current date and time. To modify it manually, disable **Time Sync**.
- **Time Zone:** Set the time reference of the current location.
- **Time Sync:** Synchronize the server and the time. If you wish to synchronize the server and the time, enable Time Sync.
- **Date Format:** Set the date format. You can select among **YYYY/MM/DD**, **MM/DD/YYYY** and **DD/MM/YYYY**.
- **Time Format:** Set the time format. You can select either **24-Hour** or **AM/PM**.

## Daylight Saving Time

You can use the device by applying daylight saving time. Set the start and end time correctly.

- 1 Press  and authenticate with the Admin level credential.
- 2 Select **DEVICE** → **Daylight Saving Time** and press  to add additional daylight-saving time.
- 3 Select the desired item and change the setting.

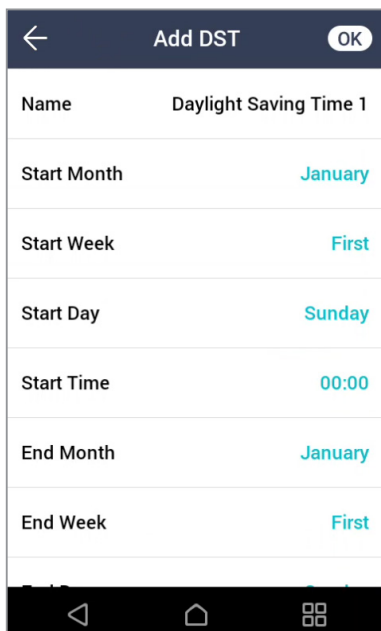

Add DST	
Name	Daylight Saving Time 1
Start Month	January
Start Week	First
Start Day	Sunday
Start Time	00:00
End Month	January
End Week	First

- **Name:** Check the name of daylight-saving time.
  - **Start Month / Start Week / Start Day / Start Time:** Set details of when the daylight-saving time option begins.
  - **End Month / End Week / End Day / End Time:** Set details of when the daylight-saving time ends.
- 4 To save settings, press **OK**.

## Device Info

You can view the model name, device ID, serial number, firmware version of device ID, and MAC address.

- 1 Press  and authenticate with the Admin level credential.
- 2 Select **DEVICE** → **Device Info**. You can view the information including **Model Name**, **Device ID**, **Serial No.**, **HW**, **FW**, **Kernel**, and **MAC**.

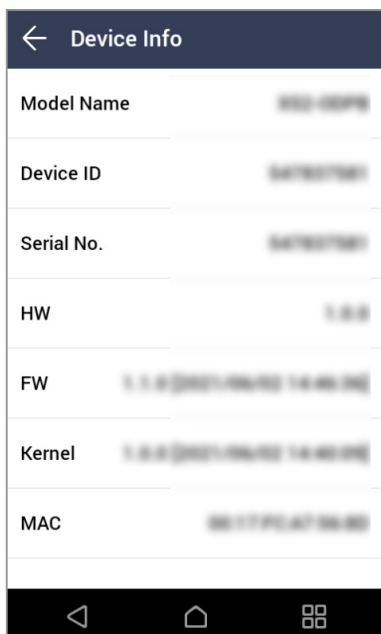

## Memory Info

View the status of memory usage.

- 1 Press  and authenticate with the Admin level credential.
- 2 Select **DEVICE** → **Memory Info**. You can view the memory usage status of the device.

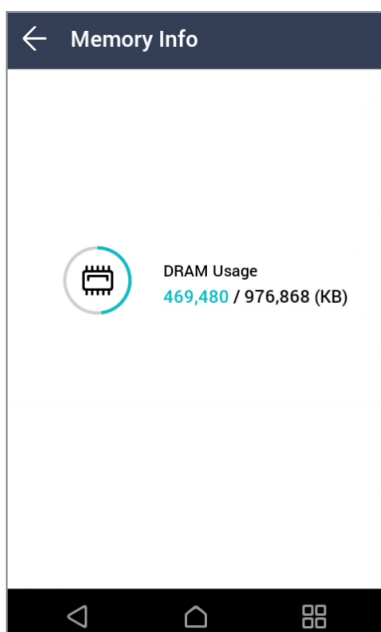

## USB Memory

Connect USB Memory and import user information to the device or export log and user information from the device. Upgrade the firmware.

- 1 Press  and authenticate with the Admin level credential.
- 2 Select **DEVICE** → **USB Memory**.
- 3 Select the desired item and change the setting.

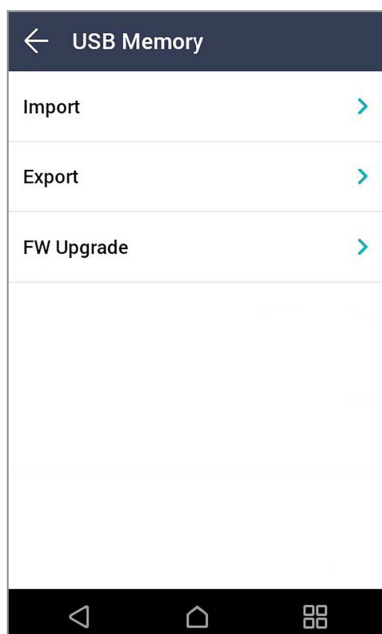

- **Import:** Import user information from the connected USB memory.
- **Export:** Select information you wish to export to the connected USB memory.
- **FW Upgrade:** Upgrade the firmware if the firmware files are saved in the connected USB memory.



Do not disconnect the power supply while upgrading the firmware of the device. The device may malfunction.



The type of supported USB memory is as follows. If you use a different type of USB memory, the function may not operate normally.

- Samsung Electronics: SUM-LSB 8 GB, SUM-PSB 8 GB, SUM-PSB 16 GB, SUM-BSG 32 GB
- LG Electronics: XTICK J3 WINDY 8 GB, SMART USB MU1 White 8 GB, MU 1 USB 32 GB, MU28GBC 32 GB, XTICK MOBY J1 16 GB
- SanDisk: Cruzer 16 GB, Cruzer Blade CZ50 4 GB, Cruzer Blade CZ50 32 GB, CZ48 Ultra USB 3.0 64 GB, CZ80 USB3.0 64 GB, CZ52 64 GB, Cruzer Glide Z60 128 GB, Cruzer Force CZ71 32 GB
- Sony: Micro Vault Click 8 GB, MicroVault CLICK 16 GB, USM-SA1 32 GB
- Transcend: JetFlash 760 8 GB, JetFlash 760 32 GB, JetFlash 500 8 GB
- Memorette: MINI500 8 GB
- A-DATA: S102 PRO 8 GB
- Trigem Pastel 8 GB

The supported USB flash drives listed above were all tested with USB Type-A. To connect these USB flash drives to X-Station 2, a separate USB Type-C gender is required.

## Secure Tamper

When the tamper is turned on, you can set to delete the entire user, the entire log, and the security key.

- 1 Press  and authenticate with the Admin level credential.
- 2 Select **DEVICE**.
- 3 Activate **Secure Tamper** to delete data of all registered users, all logs, and secure keys when a temper event occurs.

## Restart Device

The user can restart the device.

- 1 Press  and authenticate with the Admin level credential.
- 2 Select **DEVICE** → **Restart Device**.
- 3 To restart the device, press **OK**. To return to the previous screen, press **Cancel**.

## Restore Default

Device settings, network settings, and operator levels will be reset.

- 1 Press  and authenticate with the Admin level credential.
- 2 Select **DEVICE** → **Restore Default**.
  - **All settings:** You can reset all settings stored on the device. Press **OK** to reset all device settings. To return to the previous screen, press **Cancel**.
  - **Keep Network Settings:** You can reset all settings except network settings. Press **OK** to reset all settings except network settings. To return to the previous screen, press **Cancel**.
  - **Factory Default:** You can delete all the information saved in the device and the root certificate and restore default settings.
  - **Delete the Root Certificate:** You can delete the root certificate saved in the device.
- 3 If you proceed to restore the defaults, the device will restart.



- When you reset, the operator level will be reset as well. After resetting, make sure to set the operator level again.
- Language setting will not change after resetting.
- **Factory Default** menu can be used when the root certificate is saved in the device.
- **Delete the Root Certificate** menu can be used only when the root certificate is saved in the device and Administrator has been designated.

## User ID Type



You can set the type of user ID to be registered on the device to a combination of alphabetic characters, numbers, and symbols (., -).

- 1 Press  and authenticate with the Admin level credential.
- 2 Select **DEVICE** → **User ID Type**.
- 3 Change to the desired item and press **OK**.

# Event Log

## Search Log

You can set a condition and search a log.

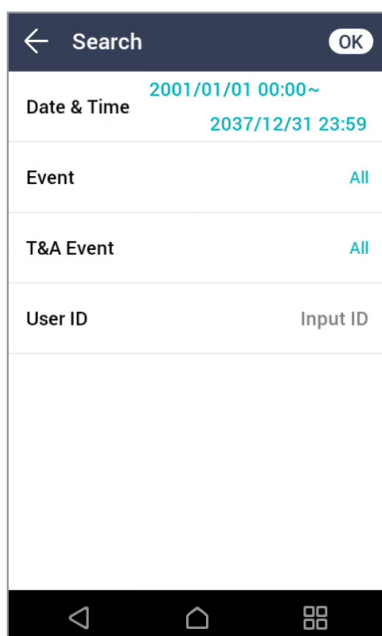

- 1 Press  and authenticate with the Admin level credential.
- 2 Select **EVENT LOG**. All event logs appear.
- 3 Press  to search a specific log and change the condition.



- 4 Press **OK**. A log that matches the condition will be displayed on the screen.



## Delete All Logs

You can delete all saved logs.

- 1 Press  and authenticate with the Admin level credential.
- 2 Select **EVENT LOG**.
- 3 To delete all logs, select  and then press **OK**. To return to the previous screen, press **Cancel**.

## View Log Usage

You can check the status of log usage.

- 1 Press  and authenticate with the Admin level credential.
- 2 Select **EVENT LOG** → . You can check the capacity of event and image logs on the device.

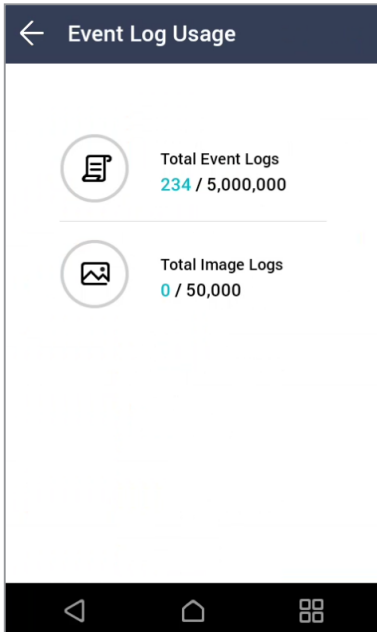



# Troubleshooting

This troubleshooting provides information to solve unexpected issues that you may encounter when using the device.

Category	Problem	Solution
Power	The power is being supplied but the device does not operate.	<ul style="list-style-type: none"><li>• If the terminal and the bracket are far away from each other, the device may not operate due to the temper switch.</li><li>• Check the adapter or the power cable.</li></ul>
PIN	I lost my PIN.	<ul style="list-style-type: none"><li>• For a normal user PIN, request it from the administrator and enter it again.</li><li>• If you have lost the Admin PIN, contact the installation company.</li></ul>
	I entered my PIN and pressed the <b>OK</b> button, but I still cannot open the door.	<ul style="list-style-type: none"><li>• Check if you have entered the registered PIN correctly.</li><li>• Check if you have changed the PIN recently.</li><li>• If you cannot remember the PIN, request it from the administrator and enter it again.</li></ul>
QR/Barcode	It fails to scan a QR/Barcode.	<ul style="list-style-type: none"><li>• Refer to <a href="#">How to scan a QR/Barcode</a> and try again.</li><li>• Position the QR/Barcode in the center of the scan screen of the device.</li><li>• Adjust the brightness of your smartphone so that the device can read the QR/Barcode clearly and try again.</li><li>• If the problem persists, contact the administrator who issued the QR/Barcode.</li></ul>
Door Lock	The door cannot be locked when I close the door.	<ul style="list-style-type: none"><li>• The electric lock may be malfunctioning. Have an inspection through the installation company.</li></ul>
Time	Suddenly the time has become incorrect.	<ul style="list-style-type: none"><li>• X-Station 2 is equipped with a built-in battery but if power is not supplied for a long time, the built-in battery may die, causing the time to become incorrect. You can correct the time by referring to <a href="#">Date &amp; Time</a>.</li></ul>
Admin Access	I lost my Admin PIN, so I cannot access the Admin mode.	<ul style="list-style-type: none"><li>• The administrator grants an access permission in X-Station 2, so only the administrator can access the Admin menu.</li><li>• If you have lost the Admin PIN, contact the installation company.</li></ul>

# Product specifications

Category	Feature	Specification
Credential	RF Option	<ul style="list-style-type: none"> <li>XS2-ODPB: 125 kHz EM &amp; 13.56 MHz MIFARE, MIFARE Plus, DESFire, DESFire EV1/EV2/EV3<sup>1)</sup>, FeliCa</li> <li>XS2-OAPB: 125 kHz EM, HID Prox &amp; 13.56 MHz MIFARE, MIFARE Plus, DESFire, DESFire EV1/EV2/EV3<sup>1)</sup>, FeliCa, iCLASS SE/SR/Seos</li> </ul>
	RF Read Range <sup>2)</sup>	EM/HID Prox/MIFARE/DESFire/HID iCLASS: 50 mm, Felica: 30 mm
	Mobile	NFC, BLE
	Scramble Keypad (PIN)	Supported
	QR/Barcode <sup>3)</sup>	Supported <sup>4)</sup>
General	CPU	1.5 GHz Quad Core
	Memory	16 GB Flash + 1 GB RAM
	Crypto Chip	Supported
	LCD Type	4" IPS color LCD
	LCD Resolution	480 x 800
	Sound	24 bit
	Operating Temperature	-20 °C ~ 50 °C
	Storage Temperature	-40 °C ~ 70 °C
	Operating Humidity	0 % ~ 80 %, non-condensing
	Storage Humidity	0 % ~ 90 %, non-condensing
	Camera Type	CMOS 2M pixels
	Camera Resolution	1600 x 1200
	Dimension (W x H x D)	82 x 208.5 x 53 (Bottom) / 25.9 (Top) (mm)
	Weight	<ul style="list-style-type: none"> <li>Device: 375 g</li> <li>Bracket: 86 g (Including washer and bolt)</li> </ul>
IP Rating	IP65	
Certificates	CE, UKCA, KC, FCC, IC, RCM, BIS, ANATEL, SIG, RoHS, REACH, WEEE	
Fingerprint	Image Dimension	300 x 400 pixels
	Resolution	500 dpi
	Template	SUPREMA / ISO19794-2, ANSI-378
	Extractor / Matcher	MINEX certified and compliant
	Sensor Certificates	FBI PIV and FBI Mobile ID FAP20
	Live Fingerprint Detection	Supported (SW-based)
Capacity	Max. User	500,000 <sup>5)</sup>
	Max. Credential (1:N)	Fingerprint: 100,000
	Max. Credential (1:1)	<ul style="list-style-type: none"> <li>Fingerprint: 500,000</li> <li>Card: 500,000</li> <li>PIN: 500,000</li> </ul>
	Max. Text Log	5,000,000
	Max. Image Log	50,000

Category	Feature	Specification
Interface	Ethernet	Supported (10/100 Mbps, auto MDI/MDI-X)
	RS-485	1 ch Master or Slave (Selectable)
	RS-485 Communication Protocol	OSDP V2 compliant
	Wiegand	1 ch Input or Output (Selectable)
	TTL Input	2 ch Inputs
	Relay	1 Relay
	USB	USB 2.0 (Host)
	PoE	Supported (IEEE 802.3af compliant)
	Tamper	Supported
Electrical	Power	<ul style="list-style-type: none"> <li>Voltage: 12 Vdc</li> <li>Current: Max. 0.8 A</li> </ul>
		<ul style="list-style-type: none"> <li>Voltage: 24 Vdc</li> <li>Current: Max. 0.5 A</li> </ul>
	Switch Input VIH	<ul style="list-style-type: none"> <li>Min.: 3 V</li> <li>Max.: 5 V</li> </ul>
	Switch Input VIL	Max.: 1 V
	Switch Pull-up Resistance	4.7 k $\Omega$ (The input pots are pulled up with 4.7 k $\Omega$ .)
	Wiegand Output VOH	More than 4.8 V
	Wiegand Output VOL	Less than 0.2 V
	Wiegand Output Pull-up Resistance	Internally pulled up with 1 k $\Omega$
	Relay	2 A @ 30 VDC Resistive load 1 A @ 30 VDC Inductive load

- 1) DESFire EV2/EV3 cards are supported by having backward compatibility of DESFire EV1 cards. CSN and smart card functions are compatible with X-Station 2.
- 2) RF read range will vary depending on installation environment.
- 3) Supports QR/Barcodes composed of up to 32 ASCII code strings.
- 4) Requires a separate license.
- 5) The number of users registered without having any credential data.

## Dimensions

(Unit: mm)

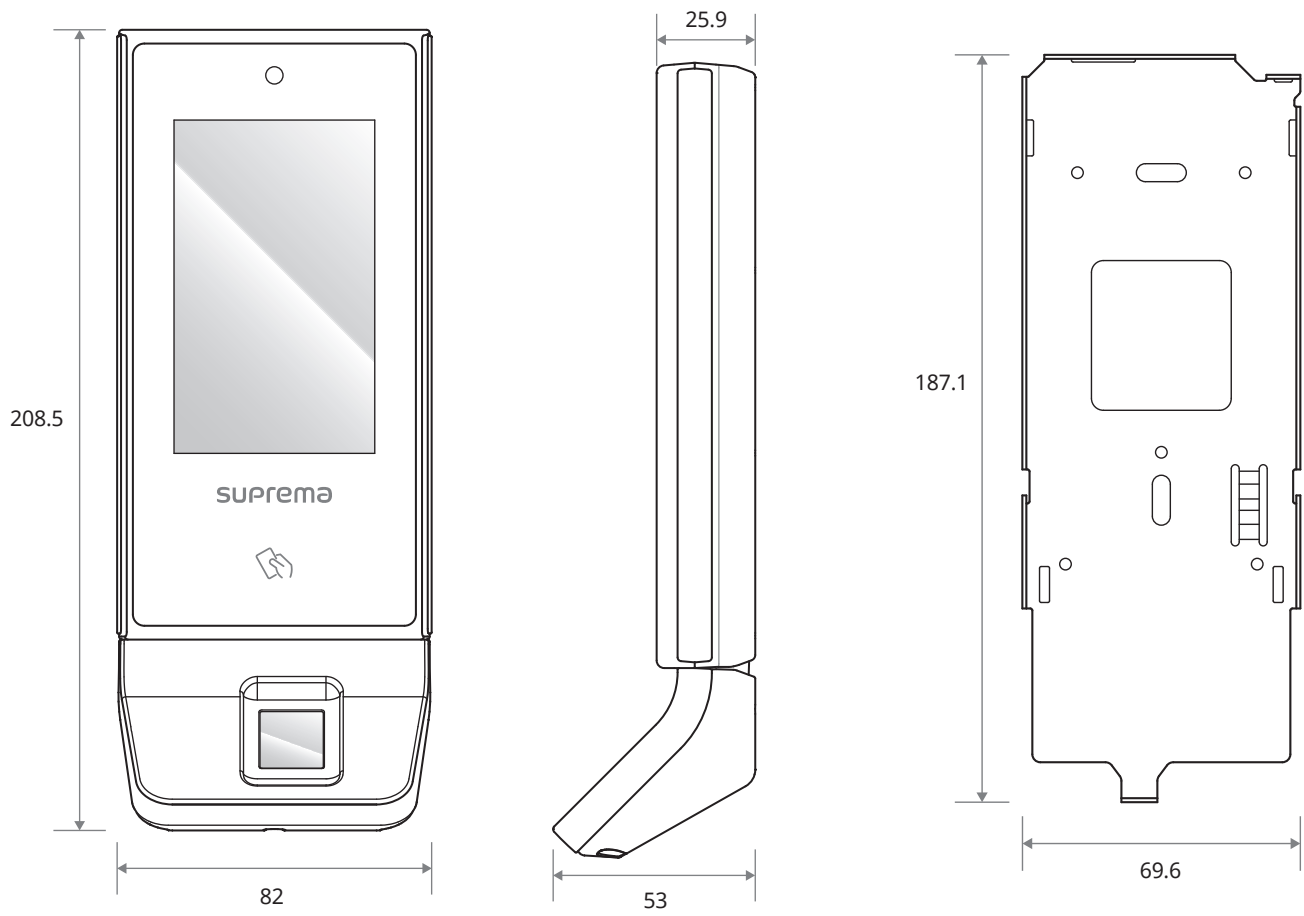

## FCC compliance information

THIS DEVICE COMPLIES WITH PART 15 OF THE FCC RULES.

Operation is subject to the following two conditions:

- (1) This device may not cause harmful interference, and
- (2) This device must accept any interference received, including interference that may cause undesired operation.



This equipment has been tested and found to comply with the limits for a Class A digital device, pursuant to part 15 of the FCC Rules. These limits are designed to provide reasonable protection against harmful interference in a residential installation. This equipment generates, uses, and can radiate radio frequency energy and, if not installed and used in accordance with the instructions, may cause harmful interference to radio communications. However, there is no guarantee that interference will not occur in a particular installation. If this equipment does cause harmful interference to radio or television reception, which can be determined by turning the equipment off and on, the user is encouraged to try to correct the interference by one or more of the following measures:

- Reorient or relocate the receiving antenna.
- Increase the separation between the equipment and receiver.
- Connect the equipment into an outlet on a circuit different from that to which the receiver is connected.
- Consult the dealer or an experienced radio/TV technician for help.

Modifications not expressly approved by the manufacturer could void the user's authority to operate the equipment under FCC rules..

- This appliance and its antenna must not be co-located or operation in conjunction with any other antenna or transmitter.
- A minimum separation distance of 20 cm must be maintained between the antenna and the person for this appliance to satisfy the RF exposure requirements.

## EU Declaration of Conformity (CE)

This product is CE marked according to the provisions of the Radio Equipment Directive (RED) 2014/53/EU. Hereby, Suprema Inc. declares that this product is in compliance with the essential requirements and other relevant provisions of Radio Equipment Directive (RED) 2014/53/EU.

- Bluetooth Transmit Power: -0.1 dBm
- Bluetooth Frequency: 2402~2480 MHz
- NFC Frequency: 13.56 MHz
- RFID Frequency: 13.56 MHz + 125 kHz

For more information, contact us at the following contact information.

Suprema Inc.

Website: <https://www.supremainc.com>

Address: 17F Parkview Tower, 248, Jeongjail-ro, Bundang- gu, Seongnam-si, Gyeonggi-do, 13554, Rep. of KOREA

Tel: +82-31-783-4502 / Fax: +82-31-783-4503

# Appendices

## Disclaimers

- Information in this document is provided in connection with Suprema products.
- The right to use is acknowledged only for Suprema products included in the terms and conditions of use or sale for such products guaranteed by Suprema. No license, express or implied, by estoppel or otherwise, to any intellectual property is granted by this document.
- Except as expressly stated in an agreement between you and Suprema, Suprema assumes no liability whatsoever, and Suprema disclaims all warranties, express or implied including, without limitation, relating to fitness for a particular purpose, merchantability, or noninfringement.
- All warranties are VOID if Suprema products have been: 1) improperly installed or where the serial numbers, warranty date or quality assurance decals on the hardware are altered or removed; 2) used in a manner other than as authorized by Suprema; 3) modified, altered or repaired by a party other than Suprema or a party authorized by Suprema; or 4) operated or maintained in unsuitable environmental conditions.
- Suprema products are not intended for use in medical, lifesaving, life-sustaining applications, or other applications in which the failure of the Suprema product could create a situation where personal injury or death may occur. Should you purchase or use Suprema products for any such unintended or unauthorized application, you shall indemnify and hold Suprema and its officers, employees, subsidiaries, affiliates, and distributors harmless against all claims, costs, damages, and expenses, and reasonable attorney fees arising out of, directly or indirectly, any claim of personal injury or death associated with such unintended or unauthorized use, even if such claim alleges that Suprema was negligent regarding the design or manufacture of the part.
- Suprema reserves the right to make changes to specifications and product descriptions at any time without notice to improve reliability, function, or design.
- Personal information, in the form of authentication messages and other relative information, may be stored within Suprema products during usage. Suprema does not take responsibility for any information, including personal information, stored within Suprema's products that are not within Suprema's direct control or as stated by the relevant terms and conditions. When any stored information, including personal information, is used, it is the responsibility of the product users to comply with national legislation (such as GDPR) and to ensure proper handling and processing.
- You must not rely on the absence or characteristics of any features or instructions marked "reserved" or "undefined." Suprema reserves these for future definition and shall have no responsibility whatsoever for conflicts or incompatibilities arising from future changes to them.
- Except as expressly set forth herein, to the maximum extent permitted by law, the Suprema products are sold "as is".
- Contact your local Suprema sales office or your distributor to obtain the latest specifications and before placing your product order.

## Copyright notice

The copyright of this document is vested in Suprema. The rights of other product names, trademarks and registered trademarks are vested in each individual or organization that owns such rights.

## Open Source License

- The software of this product is based on "Linux Kernel 4.x", which is licensed under GPL. As for GPL, please refer to the [GNU General Public License](#) in this manual.
- This product uses the "BoringSSL", which is licensed under the OpenSSL and Original SSLeay licenses. As for the OpenSSL and Original SSLeay licenses, please refer to [BoringSSL License](#) in this manual.
- This product uses the "Original SSLeay", which is licensed under the Original SSLeay licenses. As for the Original SSLeay licenses, please refer to [Original SSLeay License](#) in this manual.
- This product uses the "AOSP", which is licensed under the Apache License 2.0. As for the Apache License 2.0, please refer to [Apache License](#) in this manual.
- To request the modified source code based on Linux Kernel 4.x and the source code of BoringSSL, Original SSLeay, and AOSP, which are included in this product, please contact us at [support.supremainc.com](mailto:support.supremainc.com).

## GNU General Public License

Version 3, 29 June 2007

Copyright © 2007 Free Software Foundation, Inc. <<http://fsf.org/>>

Everyone is permitted to copy and distribute verbatim copies of this license document, but changing it is not allowed.

### Preamble

The GNU General Public License is a free, copyleft license for software and other kinds of works.

The licenses for most software and other practical works are designed to take away your freedom to share and change the works. By contrast, the GNU General Public License is intended to guarantee your freedom to share and change all versions of a program--to make sure it remains free software for all its users. We, the Free Software Foundation, use the GNU General Public License for most of our software; it applies also to any other work released this way by its authors. You can apply it to your programs, too.

When we speak of free software, we are referring to freedom, not price. Our General Public Licenses are designed to make sure that you have the freedom to distribute copies of free software (and charge for them if you wish), that you receive source code or can get it if you want it, that you can change the software or use pieces of it in new free programs, and that you know you can do these things.

To protect your rights, we need to prevent others from denying you these rights or asking you to surrender the rights. Therefore, you have certain responsibilities if you distribute copies of the software, or if you modify it: responsibilities to respect the freedom of others.

For example, if you distribute copies of such a program, whether gratis or for a fee, you must pass on to the recipients the same freedoms that you received. You must make sure that they, too, receive or can get the source code. And you must show them these terms so they know their rights.

Developers that use the GNU GPL protect your rights with two steps: (1) assert copyright on the software, and (2) offer you this License giving you legal permission to copy, distribute and/or modify it.

For the developers' and authors' protection, the GPL clearly explains that there is no warranty for this free software. For both users' and authors' sake, the GPL requires that modified versions be marked as changed, so that their problems will not be attributed erroneously to authors of previous versions.

Some devices are designed to deny users access to install or run modified versions of the software inside them, although the manufacturer can do so. This is fundamentally incompatible with the aim of protecting users' freedom to change the software. The systematic pattern of such abuse occurs in the area of products for individuals to use, which is precisely where it is most unacceptable. Therefore, we have designed this version of the GPL to prohibit the practice for those products. If such problems arise substantially in other domains, we stand ready to extend this provision to those domains in future versions of the GPL, as needed to protect the freedom of users.

Finally, every program is threatened constantly by software patents. States should not allow patents to restrict development and use of software on general-purpose computers, but in those that do, we wish to avoid the special danger that patents applied to a free program could make it effectively proprietary. To prevent this, the GPL assures that patents cannot be used to render the program non-free.

The precise terms and conditions for copying, distribution and modification follow.

## TERMS AND CONDITIONS

### 0. Definitions.

“This License” refers to version 3 of the GNU General Public License.

“Copyright” also means copyright-like laws that apply to other kinds of works, such as semiconductor masks.

“The Program” refers to any copyrightable work licensed under this License. Each licensee is addressed as “you”.

“Licensees” and “recipients” may be individuals or organizations.

To “modify” a work means to copy from or adapt all or part of the work in a fashion requiring copyright permission, other than the making of an exact copy. The resulting work is called a “modified version” of the earlier work or a work “based on” the earlier work.

A “covered work” means either the unmodified Program or a work based on the Program.

To “propagate” a work means to do anything with it that, without permission, would make you directly or secondarily liable for infringement under applicable copyright law, except executing it on a computer or modifying a private copy. Propagation includes copying, distribution (with or without modification), making available to the public, and in some countries other activities as well.

To “convey” a work means any kind of propagation that enables other parties to make or receive copies. Mere interaction with a user through a computer network, with no transfer of a copy, is not conveying.

An interactive user interface displays “Appropriate Legal Notices” to the extent that it includes a convenient and prominently visible feature that (1) displays an appropriate copyright notice, and (2) tells the user that there is no warranty for the work (except to the extent that warranties are provided), that licensees may convey the work under this License, and how to view a copy of this License. If the interface presents a list of user commands or options, such as a menu, a prominent item in the list meets this criterion.

### 1. Source Code.

The “source code” for a work means the preferred form of the work for making modifications to it. “Object code” means any non-source form of a work.

A “Standard Interface” means an interface that either is an official standard defined by a recognized standards body, or, in the case of interfaces specified for a particular programming language, one that is widely used among developers working in that language.

The “System Libraries” of an executable work include anything, other than the work as a whole, that (a) is included in the normal form of packaging a Major Component, but which is not part of that Major Component, and (b) serves only to enable use of the work with that Major Component, or to implement a Standard Interface for which an implementation is available to the public in source code form. A “Major Component”, in this context, means a major essential component (kernel, window system, and so on) of the specific operating system (if any) on which the executable work runs, or a compiler used to produce the work, or an object code interpreter used to run it.

The “Corresponding Source” for a work in object code form means all the source code needed to generate, install, and (for an executable work) run the object code and to modify the work, including scripts to control those activities. However, it does not include the work's System Libraries, or general-purpose tools or generally available free programs which are used unmodified in performing those activities but which are not part of the work. For example, Corresponding Source includes interface definition files associated with source files for the work, and the source code for shared libraries and dynamically linked subprograms that the work is specifically designed to require, such as by intimate data communication or control flow between those subprograms and other parts of the work.

The Corresponding Source need not include anything that users can regenerate automatically from other parts of the Corresponding Source.

The Corresponding Source for a work in source code form is that same work.



## 2. Basic Permissions.

All rights granted under this License are granted for the term of copyright on the Program, and are irrevocable provided the stated conditions are met. This License explicitly affirms your unlimited permission to run the unmodified Program. The output from running a covered work is covered by this License only if the output, given its content, constitutes a covered work. This License acknowledges your rights of fair use or other equivalent, as provided by copyright law.

You may make, run and propagate covered works that you do not convey, without conditions so long as your license otherwise remains in force. You may convey covered works to others for the sole purpose of having them make modifications exclusively for you, or provide you with facilities for running those works, provided that you comply with the terms of this License in conveying all material for which you do not control copyright. Those thus making or running the covered works for you must do so exclusively on your behalf, under your direction and control, on terms that prohibit them from making any copies of your copyrighted material outside their relationship with you.

Conveying under any other circumstances is permitted solely under the conditions stated below. Sublicensing is not allowed; section 10 makes it unnecessary.

## 3. Protecting Users' Legal Rights From Anti-Circumvention Law.

No covered work shall be deemed part of an effective technological measure under any applicable law fulfilling obligations under article 11 of the WIPO copyright treaty adopted on 20 December 1996, or similar laws prohibiting or restricting circumvention of such measures.

When you convey a covered work, you waive any legal power to forbid circumvention of technological measures to the extent such circumvention is effected by exercising rights under this License with respect to the covered work, and you disclaim any intention to limit operation or modification of the work as a means of enforcing, against the work's users, your or third parties' legal rights to forbid circumvention of technological measures.

## 4. Conveying Verbatim Copies.

You may convey verbatim copies of the Program's source code as you receive it, in any medium, provided that you conspicuously and appropriately publish on each copy an appropriate copyright notice; keep intact all notices stating that this License and any non-permissive terms added in accord with section 7 apply to the code; keep intact all notices of the absence of any warranty; and give all recipients a copy of this License along with the Program.

You may charge any price or no price for each copy that you convey, and you may offer support or warranty protection for a fee.

## 5. Conveying Modified Source Versions.

You may convey a work based on the Program, or the modifications to produce it from the Program, in the form of source code under the terms of section 4, provided that you also meet all of these conditions:

- a) The work must carry prominent notices stating that you modified it, and giving a relevant date.
- b) The work must carry prominent notices stating that it is released under this License and any conditions added under section 7. This requirement modifies the requirement in section 4 to "keep intact all notices".
- c) You must license the entire work, as a whole, under this License to anyone who comes into possession of a copy. This License will therefore apply, along with any applicable section 7 additional terms, to the whole of the work, and all its parts, regardless of how they are packaged. This License gives no permission to license the work in any other way, but it does not invalidate such permission if you have separately received it.
- d) If the work has interactive user interfaces, each must display Appropriate Legal Notices; however, if the Program has interactive interfaces that do not display Appropriate Legal Notices, your work need not make them do so.

A compilation of a covered work with other separate and independent works, which are not by their nature extensions of the covered work, and which are not combined with it such as to form a larger program, in or on a volume of a storage or distribution medium, is called an "aggregate" if the compilation and its resulting copyright are not used to limit the access or legal rights of the compilation's users beyond what the individual works permit. Inclusion of a covered work in an aggregate does not cause this License to apply to the other parts of the aggregate.

## 6. Conveying Non-Source Forms.

You may convey a covered work in object code form under the terms of sections 4 and 5, provided that you also convey the machine-readable Corresponding Source under the terms of this License, in one of these ways:

- a) Convey the object code in, or embodied in, a physical product (including a physical distribution medium), accompanied by the Corresponding Source fixed on a durable physical medium customarily used for software interchange.
- b) Convey the object code in, or embodied in, a physical product (including a physical distribution medium), accompanied by a written offer, valid for at least three years and valid for as long as you offer spare parts or customer support for that product model, to give anyone who possesses the object code either (1) a copy of the Corresponding Source for all the software in the product that is covered by this License, on a durable physical medium customarily used for software interchange, for a price no more than your reasonable cost of physically performing this conveying of source, or (2) access to copy the Corresponding Source from a network server at no charge.
- c) Convey individual copies of the object code with a copy of the written offer to provide the Corresponding Source. This alternative is allowed only occasionally and noncommercially, and only if you received the object code with such an offer, in accord with subsection 6b.
- d) Convey the object code by offering access from a designated place (gratis or for a charge), and offer equivalent access to the Corresponding Source in the same way through the same place at no further charge. You need not require recipients to copy the Corresponding Source along with the object code. If the place to copy the object code is a network server, the Corresponding Source may be on a different server (operated by you or a third party) that supports equivalent copying facilities, provided you maintain clear directions next to the object code saying where to find the Corresponding Source. Regardless of what server hosts the Corresponding Source, you remain obligated to ensure that it is available for as long as needed to satisfy these requirements.
- e) Convey the object code using peer-to-peer transmission, provided you inform other peers where the object code and Corresponding Source of the work are being offered to the general public at no charge under subsection 6d.

A separable portion of the object code, whose source code is excluded from the Corresponding Source as a System Library, need not be included in conveying the object code work.

A "User Product" is either (1) a "consumer product", which means any tangible personal property which is normally used for personal, family, or household purposes, or (2) anything designed or sold for incorporation into a dwelling. In determining whether a product is a consumer product, doubtful cases shall be resolved in favor of coverage. For a particular product received by a particular user, "normally used" refers to a typical or common use of that class of product, regardless of the status of the particular user or of the way in which the particular user actually uses, or expects or is expected to use, the product. A product is a consumer product regardless of whether the product has substantial commercial, industrial or non-consumer uses, unless such uses represent the only significant mode of use of the product.

"Installation Information" for a User Product means any methods, procedures, authorization keys, or other information required to install and execute modified versions of a covered work in that User Product from a modified version of its Corresponding Source. The information must suffice to ensure that the continued functioning of the modified object code is in no case prevented or interfered with solely because modification has been made.

If you convey an object code work under this section in, or with, or specifically for use in, a User Product, and the conveying occurs as part of a transaction in which the right of possession and use of the User Product is transferred to the recipient in perpetuity or for a fixed term (regardless of how the transaction is characterized), the Corresponding Source conveyed under this section must be accompanied by the Installation Information. But this requirement does not apply if neither you nor any third party retains the ability to install modified object code on the User Product (for example, the work has been installed in ROM).

The requirement to provide Installation Information does not include a requirement to continue to provide support service, warranty, or updates for a work that has been modified or installed by the recipient, or for the User Product in which it has been modified or installed. Access to a network may be denied when the modification itself materially and adversely affects the operation of the network or violates the rules and protocols for communication across the network.

Corresponding Source conveyed, and Installation Information provided, in accord with this section must be in a format that is publicly documented (and with an implementation available to the public in source code form), and must require no special password or key for unpacking, reading or copying.

## 7. Additional Terms.

“Additional permissions” are terms that supplement the terms of this License by making exceptions from one or more of its conditions. Additional permissions that are applicable to the entire Program shall be treated as though they were included in this License, to the extent that they are valid under applicable law. If additional permissions apply only to part of the Program, that part may be used separately under those permissions, but the entire Program remains governed by this License without regard to the additional permissions.

When you convey a copy of a covered work, you may at your option remove any additional permissions from that copy, or from any part of it. (Additional permissions may be written to require their own removal in certain cases when you modify the work.) You may place additional permissions on material, added by you to a covered work, for which you have or can give appropriate copyright permission.

Notwithstanding any other provision of this License, for material you add to a covered work, you may (if authorized by the copyright holders of that material) supplement the terms of this License with terms:

- a) Disclaiming warranty or limiting liability differently from the terms of sections 15 and 16 of this License; or
- b) Requiring preservation of specified reasonable legal notices or author attributions in that material or in the Appropriate Legal Notices displayed by works containing it; or
- c) Prohibiting misrepresentation of the origin of that material, or requiring that modified versions of such material be marked in reasonable ways as different from the original version; or
- d) Limiting the use for publicity purposes of names of licensors or authors of the material; or
- e) Declining to grant rights under trademark law for use of some trade names, trademarks, or service marks; or
- f) Requiring indemnification of licensors and authors of that material by anyone who conveys the material (or modified versions of it) with contractual assumptions of liability to the recipient, for any liability that these contractual assumptions directly impose on those licensors and authors.

All other non-permissive additional terms are considered “further restrictions” within the meaning of section 10. If the Program as you received it, or any part of it, contains a notice stating that it is governed by this License along with a term that is a further restriction, you may remove that term. If a license document contains a further restriction but permits relicensing or conveying under this License, you may add to a covered work material governed by the terms of that license document, provided that the further restriction does not survive such relicensing or conveying.

If you add terms to a covered work in accord with this section, you must place, in the relevant source files, a statement of the additional terms that apply to those files, or a notice indicating where to find the applicable terms.

Additional terms, permissive or non-permissive, may be stated in the form of a separately written license, or stated as exceptions; the above requirements apply either way.

## 8. Termination.

You may not propagate or modify a covered work except as expressly provided under this License. Any attempt otherwise to propagate or modify it is void, and will automatically terminate your rights under this License (including any patent licenses granted under the third paragraph of section 11).

However, if you cease all violation of this License, then your license from a particular copyright holder is reinstated (a) provisionally, unless and until the copyright holder explicitly and finally terminates your license, and (b) permanently, if the copyright holder fails to notify you of the violation by some reasonable means prior to 60 days after the cessation.

Moreover, your license from a particular copyright holder is reinstated permanently if the copyright holder notifies you of the violation by some reasonable means, this is the first time you have received notice of violation of this License (for any work) from that copyright holder, and you cure the violation prior to 30 days after your receipt of the notice.

Termination of your rights under this section does not terminate the licenses of parties who have received copies or rights from you under this License. If your rights have been terminated and not permanently reinstated, you do not qualify to receive new licenses for the same material under section 10.

## 9. Acceptance Not Required for Having Copies.

You are not required to accept this License in order to receive or run a copy of the Program. Ancillary propagation of a covered work occurring solely as a consequence of using peer-to-peer transmission to receive a copy likewise does not require acceptance. However, nothing other than this License grants you permission to propagate or modify any covered work. These actions infringe copyright if you do not accept this License. Therefore, by modifying or propagating a covered work, you indicate your acceptance of this License to do so.

## 10. Automatic Licensing of Downstream Recipients.

Each time you convey a covered work, the recipient automatically receives a license from the original licensors, to run, modify and propagate that work, subject to this License. You are not responsible for enforcing compliance by third parties with this License.

An “entity transaction” is a transaction transferring control of an organization, or substantially all assets of one, or subdividing an organization, or merging organizations. If propagation of a covered work results from an entity transaction, each party to that transaction who receives a copy of the work also receives whatever licenses to the work the party's predecessor in interest had or could give under the previous paragraph, plus a right to possession of the Corresponding Source of the work from the predecessor in interest, if the predecessor has it or can get it with reasonable efforts.

You may not impose any further restrictions on the exercise of the rights granted or affirmed under this License. For example, you may not impose a license fee, royalty, or other charge for exercise of rights granted under this License, and you may not initiate litigation (including a cross-claim or counterclaim in a lawsuit) alleging that any patent claim is infringed by making, using, selling, offering for sale, or importing the Program or any portion of it.

## 11. Patents.

A “contributor” is a copyright holder who authorizes use under this License of the Program or a work on which the Program is based. The work thus licensed is called the contributor's “contributor version”.

A contributor's “essential patent claims” are all patent claims owned or controlled by the contributor, whether already acquired or hereafter acquired, that would be infringed by some manner, permitted by this License, of making, using, or selling its contributor version, but do not include claims that would be infringed only as a consequence of further modification of the contributor version. For purposes of this definition, “control” includes the right to grant patent sublicenses in a manner consistent with the requirements of this License.

Each contributor grants you a non-exclusive, worldwide, royalty-free patent license under the contributor's essential patent claims, to make, use, sell, offer for sale, import and otherwise run, modify and propagate the contents of its contributor version.

In the following three paragraphs, a “patent license” is any express agreement or commitment, however denominated, not to enforce a patent (such as an express permission to practice a patent or covenant not to sue for patent infringement). To “grant” such a patent license to a party means to make such an agreement or commitment not to enforce a patent against the party.

If you convey a covered work, knowingly relying on a patent license, and the Corresponding Source of the work is not available for anyone to copy, free of charge and under the terms of this License, through a publicly available network server or other readily accessible means, then you must either (1) cause the Corresponding Source to be so available, or (2) arrange to deprive yourself of the benefit of the patent license for this particular work, or (3) arrange, in a manner consistent with the requirements of this License, to extend the patent license to downstream recipients. “Knowingly relying” means you have actual knowledge that, but for the patent license, your conveying the covered work in a country, or your recipient's use of the covered work in a country, would infringe one or more identifiable patents in that country that you have reason to believe are valid.

If, pursuant to or in connection with a single transaction or arrangement, you convey, or propagate by procuring conveyance of, a covered work, and grant a patent license to some of the parties receiving the covered work authorizing them to use, propagate, modify or convey a specific copy of the covered work, then the patent license you grant is automatically extended to all recipients of the covered work and works based on it.

A patent license is “discriminatory” if it does not include within the scope of its coverage, prohibits the exercise of, or is conditioned on the non-exercise of one or more of the rights that are specifically granted under this License. You may not convey a covered work if you are a party to an arrangement with a third party that is in the business of distributing software, under which you make payment to the third party based on the extent of your activity of conveying the work, and under which the third party grants, to any of the parties who would receive the covered work from you, a discriminatory patent license (a) in connection with copies of the covered work conveyed by you (or copies made from those copies), or (b) primarily for and in connection with specific products or compilations that contain the covered work, unless you entered into that arrangement, or that patent license was granted, prior to 28 March 2007.

Nothing in this License shall be construed as excluding or limiting any implied license or other defenses to infringement that may otherwise be available to you under applicable patent law.

## **12. No Surrender of Others' Freedom.**

If conditions are imposed on you (whether by court order, agreement or otherwise) that contradict the conditions of this License, they do not excuse you from the conditions of this License. If you cannot convey a covered work so as to satisfy simultaneously your obligations under this License and any other pertinent obligations, then as a consequence you may not convey it at all. For example, if you agree to terms that obligate you to collect a royalty for further conveying from those to whom you convey the Program, the only way you could satisfy both those terms and this License would be to refrain entirely from conveying the Program.

## **13. Use with the GNU Affero General Public License.**

Notwithstanding any other provision of this License, you have permission to link or combine any covered work with a work licensed under version 3 of the GNU Affero General Public License into a single combined work, and to convey the resulting work. The terms of this License will continue to apply to the part which is the covered work, but the special requirements of the GNU Affero General Public License, section 13, concerning interaction through a network will apply to the combination as such.

## **14. Revised Versions of this License.**

The Free Software Foundation may publish revised and/or new versions of the GNU General Public License from time to time. Such new versions will be similar in spirit to the present version, but may differ in detail to address new problems or concerns.

Each version is given a distinguishing version number. If the Program specifies that a certain numbered version of the GNU General Public License “or any later version” applies to it, you have the option of following the terms and conditions either of that numbered version or of any later version published by the Free Software Foundation. If the Program does not specify a version number of the GNU General Public License, you may choose any version ever published by the Free Software Foundation.

If the Program specifies that a proxy can decide which future versions of the GNU General Public License can be used, that proxy’s public statement of acceptance of a version permanently authorizes you to choose that version for the Program.

Later license versions may give you additional or different permissions. However, no additional obligations are imposed on any author or copyright holder as a result of your choosing to follow a later version.

## **15. Disclaimer of Warranty.**

THERE IS NO WARRANTY FOR THE PROGRAM, TO THE EXTENT PERMITTED BY APPLICABLE LAW. EXCEPT WHEN OTHERWISE STATED IN WRITING THE COPYRIGHT HOLDERS AND/OR OTHER PARTIES PROVIDE THE PROGRAM “AS IS” WITHOUT WARRANTY OF ANY KIND, EITHER EXPRESSED OR IMPLIED, INCLUDING, BUT NOT LIMITED TO, THE IMPLIED WARRANTIES OF MERCHANTABILITY AND FITNESS FOR A PARTICULAR PURPOSE. THE ENTIRE RISK AS TO THE QUALITY AND PERFORMANCE OF THE PROGRAM IS WITH YOU. SHOULD THE PROGRAM PROVE DEFECTIVE, YOU ASSUME THE COST OF ALL NECESSARY SERVICING, REPAIR OR CORRECTION.

## **16. Limitation of Liability.**

IN NO EVENT UNLESS REQUIRED BY APPLICABLE LAW OR AGREED TO IN WRITING WILL ANY COPYRIGHT HOLDER, OR ANY OTHER PARTY WHO MODIFIES AND/OR CONVEYS THE PROGRAM AS PERMITTED ABOVE, BE LIABLE TO YOU FOR DAMAGES, INCLUDING ANY GENERAL, SPECIAL, INCIDENTAL OR CONSEQUENTIAL DAMAGES ARISING OUT OF THE USE OR INABILITY TO USE THE PROGRAM (INCLUDING BUT NOT LIMITED TO LOSS OF DATA OR DATA BEING RENDERED INACCURATE OR LOSSES SUSTAINED BY YOU OR THIRD PARTIES OR A FAILURE OF THE PROGRAM TO OPERATE WITH ANY OTHER PROGRAMS), EVEN IF SUCH HOLDER OR OTHER PARTY HAS BEEN ADVISED OF THE POSSIBILITY OF SUCH DAMAGES.



## 17. Interpretation of Sections 15 and 16.

If the disclaimer of warranty and limitation of liability provided above cannot be given local legal effect according to their terms, reviewing courts shall apply local law that most closely approximates an absolute waiver of all civil liability in connection with the Program, unless a warranty or assumption of liability accompanies a copy of the Program in return for a fee.

END OF TERMS AND CONDITIONS

## BoringSSL License

BoringSSL is a fork of OpenSSL. As such, large parts of it fall under OpenSSL licensing. Files that are completely new have a Google copyright and an ISC license. This license is reproduced at the bottom of this file.

Contributors to BoringSSL are required to follow the CLA rules for Chromium: <https://cla.developers.google.com/cla>

Files in `third_party/` have their own licenses, as described therein. The MIT license, for `third_party/flat`, which, unlike other `third_party` directories, is compiled into non-test libraries, is included below.

The OpenSSL toolkit stays under a dual license, i.e. both the conditions of the OpenSSL License and the original SSLeay license apply to the toolkit. See below for the actual license texts. Actually both licenses are BSD-style Open Source licenses. In case of any license issues related to OpenSSL please contact [openssl-core@openssl.org](mailto:openssl-core@openssl.org).

The following are Google-internal bug numbers where explicit permission from some authors is recorded for use of their work. (This is purely for our own record keeping.)

27287199

27287880

27287883

## OpenSSL License

Copyright (c) 1998-2011 The OpenSSL Project. All rights reserved.

Redistribution and use in source and binary forms, with or without modification, are permitted provided that the following conditions are met:

1. Redistributions of source code must retain the above copyright notice, this list of conditions and the following disclaimer.
2. Redistributions in binary form must reproduce the above copyright notice, this list of conditions and the following disclaimer in the documentation and/or other materials provided with the distribution.
3. All advertising materials mentioning features or use of this software must display the following acknowledgment: "This product includes software developed by the OpenSSL Project for use in the OpenSSL Toolkit. (<http://www.openssl.org/>)"
4. The names "OpenSSL Toolkit" and "OpenSSL Project" must not be used to endorse or promote products derived from this software without prior written permission. For written permission, please contact [openssl-core@openssl.org](mailto:openssl-core@openssl.org).
5. Products derived from this software may not be called "OpenSSL" nor may "OpenSSL" appear in their names without prior written permission of the OpenSSL Project.
6. Redistributions of any form whatsoever must retain the following acknowledgment: "This product includes software developed by the OpenSSL Project for use in the OpenSSL Toolkit (<http://www.openssl.org/>)"

THIS SOFTWARE IS PROVIDED BY THE OpenSSL PROJECT ``AS IS'' AND ANY EXPRESSED OR IMPLIED WARRANTIES, INCLUDING, BUT NOT LIMITED TO, THE IMPLIED WARRANTIES OF MERCHANTABILITY AND FITNESS FOR A PARTICULAR PURPOSE ARE DISCLAIMED. IN NO EVENT SHALL THE OpenSSL PROJECT OR ITS CONTRIBUTORS BE LIABLE FOR ANY DIRECT, INDIRECT, INCIDENTAL, SPECIAL, EXEMPLARY, OR CONSEQUENTIAL DAMAGES (INCLUDING, BUT NOT LIMITED TO, PROCUREMENT OF SUBSTITUTE GOODS OR SERVICES; LOSS OF USE, DATA, OR PROFITS; OR BUSINESS INTERRUPTION) HOWEVER CAUSED AND ON ANY THEORY OF LIABILITY, WHETHER IN CONTRACT, STRICT LIABILITY, OR TORT (INCLUDING NEGLIGENCE OR OTHERWISE) ARISING IN ANY WAY OUT OF THE USE OF THIS SOFTWARE, EVEN IF ADVISED OF THE POSSIBILITY OF SUCH DAMAGE.

This product includes cryptographic software written by Eric Young ([eay@cryptsoft.com](mailto:eay@cryptsoft.com)). This product includes software written by Tim Hudson ([tjh@cryptsoft.com](mailto:tjh@cryptsoft.com)).

## Original SSLeay License

Copyright (C) 1995-1998 Eric Young ([eay@cryptsoft.com](mailto:eay@cryptsoft.com)) All rights reserved.

This package is an SSL implementation written by Eric Young ([eay@cryptsoft.com](mailto:eay@cryptsoft.com)). The implementation was written so as to conform with Netscapes SSL.

This library is free for commercial and non-commercial use as long as the following conditions are adhered to. The following conditions apply to all code found in this distribution, be it the RC4, RSA, lhash, DES, etc., code; not just the SSL code. The SSL documentation included with this distribution is covered by the same copyright terms except that the holder is Tim Hudson ([tjh@cryptsoft.com](mailto:tjh@cryptsoft.com)).

Copyright remains Eric Young's, and as such any Copyright notices in the code are not to be removed. If this package is used in a product, Eric Young should be given attribution as the author of the parts of the library used. This can be in the form of a textual message at program startup or in documentation (online or textual) provided with the package.

Redistribution and use in source and binary forms, with or without modification, are permitted provided that the following conditions are met:

1. Redistributions of source code must retain the copyright notice, this list of conditions and the following disclaimer.
2. Redistributions in binary form must reproduce the above copyright notice, this list of conditions and the following disclaimer in the documentation and/or other materials provided with the distribution.
3. All advertising materials mentioning features or use of this software must display the following acknowledgement: "This product includes cryptographic software written by Eric Young ([eay@cryptsoft.com](mailto:eay@cryptsoft.com))" The word 'cryptographic' can be left out if the routines from the library being used are not cryptographic related :-).
4. If you include any Windows specific code (or a derivative thereof) from the apps directory (application code) you must include an acknowledgement: "This product includes software written by Tim Hudson ([tjh@cryptsoft.com](mailto:tjh@cryptsoft.com))"

THIS SOFTWARE IS PROVIDED BY ERIC YOUNG ``AS IS" AND ANY EXPRESS OR IMPLIED WARRANTIES, INCLUDING, BUT NOT LIMITED TO, THE IMPLIED WARRANTIES OF MERCHANTABILITY AND FITNESS FOR A PARTICULAR PURPOSE ARE DISCLAIMED. IN NO EVENT SHALL THE AUTHOR OR CONTRIBUTORS BE LIABLE FOR ANY DIRECT, INDIRECT, INCIDENTAL, SPECIAL, EXEMPLARY, OR CONSEQUENTIAL DAMAGES (INCLUDING, BUT NOT LIMITED TO, PROCUREMENT OF SUBSTITUTE GOODS OR SERVICES; LOSS OF USE, DATA, OR PROFITS; OR BUSINESS INTERRUPTION) HOWEVER CAUSED AND ON ANY THEORY OF LIABILITY, WHETHER IN CONTRACT, STRICT LIABILITY, OR TORT (INCLUDING NEGLIGENCE OR OTHERWISE) ARISING IN ANY WAY OUT OF THE USE OF THIS SOFTWARE, EVEN IF ADVISED OF THE POSSIBILITY OF SUCH DAMAGE.

The licence and distribution terms for any publically available version or derivative of this code cannot be changed. i.e. this code cannot simply be copied and put under another distribution licence [including the GNU Public Licence.]

ISC license used for completely new code in BoringSSL:

Copyright (c) 2015, Google Inc.

Permission to use, copy, modify, and/or distribute this software for any purpose with or without fee is hereby granted, provided that the above copyright notice and this permission notice appear in all copies.

THE SOFTWARE IS PROVIDED "AS IS" AND THE AUTHOR DISCLAIMS ALL WARRANTIES WITH REGARD TO THIS SOFTWARE INCLUDING ALL IMPLIED WARRANTIES OF MERCHANTABILITY AND FITNESS. IN NO EVENT SHALL THE AUTHOR BE LIABLE FOR ANY SPECIAL, DIRECT, INDIRECT, OR CONSEQUENTIAL DAMAGES OR ANY DAMAGES WHATSOEVER RESULTING FROM LOSS OF USE, DATA OR PROFITS, WHETHER IN AN ACTION OF CONTRACT, NEGLIGENCE OR OTHER TORTIOUS ACTION, ARISING OUT OF OR IN CONNECTION WITH THE USE OR PERFORMANCE OF THIS SOFTWARE.

The code in `third_party/ fiat` carries the MIT license:

Copyright (c) 2015-2016 the fiat-crypto authors (see <https://github.com/mit-plv/fiat-crypto/blob/master/AUTHORS>).

Permission is hereby granted, free of charge, to any person obtaining a copy of this software and associated documentation files (the "Software"), to deal in the Software without restriction, including without limitation the rights to use, copy, modify, merge, publish, distribute, sublicense, and/or sell copies of the Software, and to permit persons to whom the Software is furnished to do so, subject to the following conditions:

The above copyright notice and this permission notice shall be included in all copies or substantial portions of the Software.

THE SOFTWARE IS PROVIDED "AS IS", WITHOUT WARRANTY OF ANY KIND, EXPRESS OR IMPLIED, INCLUDING BUT NOT LIMITED TO THE WARRANTIES OF MERCHANTABILITY, FITNESS FOR A PARTICULAR PURPOSE AND NONINFRINGEMENT. IN NO EVENT SHALL THE AUTHORS OR COPYRIGHT HOLDERS BE LIABLE FOR ANY CLAIM, DAMAGES OR OTHER LIABILITY, WHETHER IN AN ACTION OF CONTRACT, TORT OR OTHERWISE, ARISING FROM, OUT OF OR IN CONNECTION WITH THE SOFTWARE OR THE USE OR OTHER DEALINGS IN THE SOFTWARE.

The code in `third_party/sike` also carries the MIT license:

Copyright (c) Microsoft Corporation. All rights reserved.

Permission is hereby granted, free of charge, to any person obtaining a copy of this software and associated documentation files (the "Software"), to deal in the Software without restriction, including without limitation the rights to use, copy, modify, merge, publish, distribute, sublicense, and/or sell copies of the Software, and to permit persons to whom the Software is furnished to do so, subject to the following conditions:

The above copyright notice and this permission notice shall be included in all copies or substantial portions of the Software.

THE SOFTWARE IS PROVIDED "AS IS", WITHOUT WARRANTY OF ANY KIND, EXPRESS OR IMPLIED, INCLUDING BUT NOT LIMITED TO THE WARRANTIES OF MERCHANTABILITY, FITNESS FOR A PARTICULAR PURPOSE AND NONINFRINGEMENT. IN NO EVENT SHALL THE AUTHORS OR COPYRIGHT HOLDERS BE LIABLE FOR ANY CLAIM, DAMAGES OR OTHER

LIABILITY, WHETHER IN AN ACTION OF CONTRACT, TORT OR OTHERWISE, ARISING FROM, OUT OF OR IN CONNECTION WITH THE SOFTWARE OR THE USE OR OTHER DEALINGS IN THE SOFTWARE

## Licenses for support code

Parts of the TLS test suite are under the Go license. This code is not included in BoringSSL (i.e. libcrypto and libssl) when compiled, however, so distributing code linked against BoringSSL does not trigger this license:

Copyright (c) 2009 The Go Authors. All rights reserved.

Redistribution and use in source and binary forms, with or without modification, are permitted provided that the following conditions are met:

- \* Redistributions of source code must retain the above copyright notice, this list of conditions and the following disclaimer.
- \* Redistributions in binary form must reproduce the above copyright notice, this list of conditions and the following disclaimer in the documentation and/or other materials provided with the distribution.
- \* Neither the name of Google Inc. nor the names of its contributors may be used to endorse or promote products derived from this software without specific prior written permission.

THIS SOFTWARE IS PROVIDED BY THE COPYRIGHT HOLDERS AND CONTRIBUTORS "AS IS" AND ANY EXPRESS OR IMPLIED WARRANTIES, INCLUDING, BUT NOT LIMITED TO, THE IMPLIED WARRANTIES OF MERCHANTABILITY AND FITNESS FOR A PARTICULAR PURPOSE ARE DISCLAIMED. IN NO EVENT SHALL THE COPYRIGHT OWNER OR CONTRIBUTORS BE LIABLE FOR ANY DIRECT, INDIRECT, INCIDENTAL, SPECIAL, EXEMPLARY, OR CONSEQUENTIAL DAMAGES (INCLUDING, BUT NOT LIMITED TO, PROCUREMENT OF SUBSTITUTE GOODS OR SERVICES; LOSS OF USE,

DATA, OR PROFITS; OR BUSINESS INTERRUPTION) HOWEVER CAUSED AND ON ANY THEORY OF LIABILITY, WHETHER IN CONTRACT, STRICT LIABILITY, OR TORT (INCLUDING NEGLIGENCE OR OTHERWISE) ARISING IN ANY WAY OUT OF THE USE OF THIS SOFTWARE, EVEN IF ADVISED OF THE POSSIBILITY OF SUCH DAMAGE.



## Apache License

Version 2.0, January 2004 (<http://www.apache.org/licenses/>)

### TERMS AND CONDITIONS FOR USE, REPRODUCTION, AND DISTRIBUTION

#### 0. Definitions.

"License" shall mean the terms and conditions for use, reproduction, and distribution as defined by Sections 1 through 9 of this document.

"Licensor" shall mean the copyright owner or entity authorized by the copyright owner that is granting the License.

"Legal Entity" shall mean the union of the acting entity and all other entities that control, are controlled by, or are under common control with that entity. For the purposes of this definition, "control" means (i) the power, direct or indirect, to cause the direction or management of such entity, whether by contract or otherwise, or (ii) ownership of fifty percent (50%) or more of the outstanding shares, or (iii) beneficial ownership of such entity.

"You" (or "Your") shall mean an individual or Legal Entity exercising permissions granted by this License.

"Source" form shall mean the preferred form for making modifications, including but not limited to software source code, documentation source, and configuration files.

"Object" form shall mean any form resulting from mechanical transformation or translation of a Source form, including but not limited to compiled object code, generated documentation, and conversions to other media types.

"Work" shall mean the work of authorship, whether in Source or Object form, made available under the License, as indicated by a copyright notice that is included in or attached to the work (an example is provided in the Appendix below).

"Derivative Works" shall mean any work, whether in Source or Object form, that is based on (or derived from) the Work and for which the editorial revisions, annotations, elaborations, or other modifications represent, as a whole, an original work of authorship. For the purposes of this License, Derivative Works shall not include works that remain separable from, or merely link (or bind by name) to the interfaces of, the Work and Derivative Works thereof.

"Contribution" shall mean any work of authorship, including the original version of the Work and any modifications or additions to that Work or Derivative Works thereof, that is intentionally submitted to Licensor for inclusion in the Work by the copyright owner or by an individual or Legal Entity authorized to submit on behalf of the copyright owner. For the purposes of this definition, "submitted" means any form of electronic, verbal, or written communication sent to the Licensor or its representatives, including but not limited to communication on electronic mailing lists, source code control systems, and issue tracking systems that are managed by, or on behalf of, the Licensor for the purpose of discussing and improving the Work, but excluding communication that is conspicuously marked or otherwise designated in writing by the copyright owner as "Not a Contribution."

"Contributor" shall mean Licensor and any individual or Legal Entity on behalf of whom a Contribution has been received by Licensor and subsequently incorporated within the Work.

#### 1. Grant of Copyright License.

Subject to the terms and conditions of this License, each Contributor hereby grants to You a perpetual, worldwide, non-exclusive, no-charge, royalty-free, irrevocable copyright license to reproduce, prepare Derivative Works of, publicly display, publicly perform, sublicense, and distribute the Work and such Derivative Works in Source or Object form.

#### 2. Grant of Patent License.

Subject to the terms and conditions of this License, each Contributor hereby grants to You a perpetual, worldwide, non-exclusive, no-charge, royalty-free, irrevocable (except as stated in this section) patent license to make, have made, use, offer to sell, sell, import, and otherwise transfer the Work, where such license applies only to those patent claims licensable by such Contributor that are necessarily infringed by their Contribution(s) alone or by combination of their Contribution(s) with the Work to which such Contribution(s) was submitted. If You institute patent litigation against any entity (including a cross-claim or counterclaim in a lawsuit) alleging that the Work or a Contribution incorporated within the Work constitutes direct or contributory patent infringement, then any patent licenses granted to You under this License for that Work shall terminate as of the date such litigation is filed.

### 3. Redistribution.

You may reproduce and distribute copies of the Work or Derivative Works thereof in any medium, with or without modifications, and in Source or Object form, provided that You meet the following conditions:

- (a) You must give any other recipients of the Work or Derivative Works a copy of this License; and
- (b) You must cause any modified files to carry prominent notices stating that You changed the files; and
- (c) You must retain, in the Source form of any Derivative Works that You distribute, all copyright, patent, trademark, and attribution notices from the Source form of the Work, excluding those notices that do not pertain to any part of the Derivative Works; and
- (d) If the Work includes a "NOTICE" text file as part of its distribution, then any Derivative Works that You distribute must include a readable copy of the attribution notices contained within such NOTICE file, excluding those notices that do not pertain to any part of the Derivative Works, in at least one of the following places: within a NOTICE text file distributed as part of the Derivative Works; within the Source form or documentation, if provided along with the Derivative Works; or, within a display generated by the Derivative Works, if and wherever such third-party notices normally appear. The contents of the NOTICE file are for informational purposes only and do not modify the License. You may add Your own attribution notices within Derivative Works that You distribute, alongside or as an addendum to the NOTICE text from the Work, provided that such additional attribution notices cannot be construed as modifying the License.

You may add Your own copyright statement to Your modifications and may provide additional or different license terms and conditions for use, reproduction, or distribution of Your modifications, or for any such Derivative Works as a whole, provided Your use, reproduction, and distribution of the Work otherwise complies with the conditions stated in this License.

### 4. Submission of Contributions.

Unless You explicitly state otherwise, any Contribution intentionally submitted for inclusion in the Work by You to the Licensor shall be under the terms and conditions of this License, without any additional terms or conditions. Notwithstanding the above, nothing herein shall supersede or modify the terms of any separate license agreement you may have executed with Licensor regarding such Contributions.

### 5. Trademarks.

This License does not grant permission to use the trade names, trademarks, service marks, or product names of the Licensor, except as required for reasonable and customary use in describing the origin of the Work and reproducing the content of the NOTICE file.

### 6. Disclaimer of Warranty.

Unless required by applicable law or agreed to in writing, Licensor provides the Work (and each Contributor provides its Contributions) on an "AS IS" BASIS, WITHOUT WARRANTIES OR CONDITIONS OF ANY KIND, either express or implied, including, without limitation, any warranties or conditions of TITLE, NON-INFRINGEMENT, MERCHANTABILITY, or FITNESS FOR A PARTICULAR PURPOSE. You are solely responsible for determining the appropriateness of using or redistributing the Work and assume any risks associated with Your exercise of permissions under this License.

### 7. Limitation of Liability.

In no event and under no legal theory, whether in tort (including negligence), contract, or otherwise, unless required by applicable law (such as deliberate and grossly negligent acts) or agreed to in writing, shall any Contributor be liable to You for damages, including any direct, indirect, special, incidental, or consequential damages of any character arising as a result of this License or out of the use or inability to use the Work (including but not limited to damages for loss of goodwill, work stoppage, computer failure or malfunction, or any and all other commercial damages or losses), even if such Contributor has been advised of the possibility of such damages.

### 8. Accepting Warranty or Additional Liability.

While redistributing the Work or Derivative Works thereof, You may choose to offer, and charge a fee for, acceptance of support, warranty, indemnity, or other liability obligations and/or rights consistent with this License. However, in accepting such obligations, You may act only on Your own behalf and on Your sole responsibility, not on behalf of any other Contributor, and only if You agree to indemnify, defend, and hold each Contributor harmless for any liability incurred by, or claims asserted against, such Contributor by reason of your accepting any such warranty or additional liability.

END OF TERMS AND CONDITIONS



**Suprema Inc.**

17F Parkview Tower, 248, Jeongjail-ro, Bundang-gu, Seongnam-si, Gyeonggi-do, 13554, Rep. of KOREA

Tel: +82 31 783 4502 | Fax: +82 31 783 4503 | Inquiry: sales\_sys@supremainc.com



For more information about Suprema's global branch offices,  
visit the webpage below by scanning the QR code.  
<http://www.supremainc.com/en/about/contact-us.asp>